



PHILIPS



CDI 210

- GB** User manual
- F** Mode d'emploi
- E** Manual del propietario
- NL** Gebruiksaanwijzing
- D** Bedienungsanleitung
- I** Manuale d'uso
- P** Manual de Utilização

IMPORTANT NOTE

DK

ADVARSEL!

Lithiumbatteri - Eksplosionsfare ved fejlagtig håndtering.
Udskiftning må kun ske med batteri
af samme fabrikat og type.
Levér det brugte batteri tilbage til leverandøren.

ADVARSEL!

Lithiumbatteri - Eksplosionsfare. Udskiftning må kun
foretages af en sagkyndig,
og som beskrevet i servicemanualen.

Advarsel:

Usynlig laserudstråling ved åbning når sikkerhedsafbrydere er ude af funktion. Undgå udsættelse for stråling.

Bemærk:

Netafbryderen POWER er sekundært indkoblet og afbryder ikke strømmen fra nettet. Den indbyggede netdel er derfor tilsluttet til lysnettet så længe netstikket sidder i stikkontakten.

N

Observer:

Nettbryteren POWER er sekundært innkoplet. Den innebygdenetdelen er derfor ikke frakoplet nettet så længe apparatet er tilsluttet nettkontakten.

S

Klass I laserapparat

Varning!

Om apparaten används på annat sätt än i denna bruksanvisning specificerats, kann användaren utsättas för osynlig laserstråling, som överskrider gränsen för läserklass 1.

Observera!

Strömbrytaren POWER är sekundärt kopplad och inte bryter strömmen från nätet. Den inbyggda nätdelen är därför ansluten till elnätet så länge stikproppen sitter i vägguttaget.

SF

Luokan 1 laserlaite + Klass 1 laserapparat

Varoitus!

Laitteen käyttäminen muulla kuin tässä käyttöohjeessa mainitulla tavalla saattaa altistaa käyttäjän turvallisuusluokan 1 ylittävälle näkömättömälle lasersäteille.

Huom.

Toiminnanvalitsin POWER on kytketty toisiopuolelle, eikä se kytke laitetta irti sähköverkosta. Sisäänrakennettu verkko-osa on kytkettynä sähköverkkoon aina silloin, kun pistoke on pistorasiassa.

IMPORTANT NOTE FOR USERS IN THE UK

This apparatus is fitted with an approved 13 Amp plug.
To change a fuse in this type of plug, proceed as follows:

1. Remove fuse cover and fuse.
2. Fix new fuse which should be a BS1362 5A, A.S.T.A. or BSI approved type.
3. Refit the fuse cover.

If the fitted plug is not suitable for your socket outlets, it should be cut off and an appropriate plug fitted in its place.

If the mains plug contains a fuse, this should have a value of 5A. If a plug without a fuse is used, the fuse at the distribution board should not be greater than 5A.

NOTE

The severed plug must be destroyed to avoid a possible shock hazard should it be inserted into a 13A socket.

How to connect a plug

The wires in the mains lead are coloured in accordance with the following code:

Blue - 'Neutral' (N); Brown - 'Live' (L)

1. The Blue wire must be connected to the terminal which is marked with the letter 'N' or coloured Black.
2. The Brown wire must be connected to the terminal which is marked with the letter 'L' or coloured Red.
3. Do not connect either wires to the earth terminal in the plug which is marked by the letter 'E' or by the safety earth symbol or coloured green or green-and-yellow.

Before replacing the plug cover, make certain that the cord grip is clamped over the sheath of the lead - not simply over the two wires.

GB	Englishpage 4	English
F	Françaispage 15	Français
E	Españolpágina 26	Español
NL	Nederlands.....pagina 37	Nederlands
D	Deutsch.....Seite 48	Deutsch
I	Italiano.....pagina 59	Italiano
P	Portuguêspag. 70	Português

For Customer Use:

Read carefully the information located at the bottom of your CDI player and enter below the Serial N°.

Retain this information for future reference.

Model N°. CDI 210

Serial N°.

LASER SAFETY: This unit employs a laser. Only a qualified service person should remove the cover or attempt to service this device, due to possible eye injury.

NEVER MAKE OR CHANGE CONNECTIONS WITH THE POWER SWITCHED ON.



The CDI 210 is in conformity with the EMC directive and low-voltage directive.

**CLASS 1
LASER PRODUCT**

**LUOKAN I
LASERLAITE**

**KLASS 1
LASERAPPARAT**

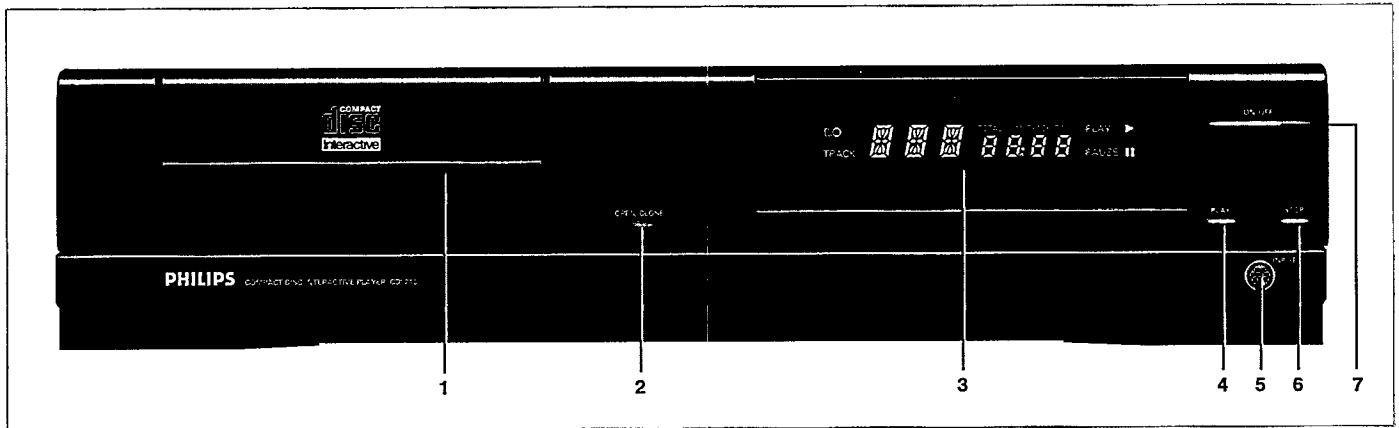

INTRODUCTION

We are pleased to introduce you to one of the most innovative products available today: the Compact Disc Interactive player. You'll be surprised how easy it is! Once correctly hooked up to your TV, you simply 'point-and-click' to explore the intriguing new world of interactive Compact Disc.

Your CD-i player also plays CD-DA (audio compact discs) and audio tracks from CD-ROM discs. In addition it can play the following disc types: Photo CD, CD-i Ready, CD Bridge and CD Graphics (CD+G).

By simply plugging in the optional Digital Video Cartridge, you can upgrade the player to run interactive Digital Video titles including movies, music videos and high-power action games as well as Video CD's.

A wide variety of optional accessories enhances the player's flexibility. Contact your supplier.

We are confident that you will find this product surprisingly easy to use, and quite unique in its fascination.

FRONT OF PLAYER

- 1 Disc loading tray.
- 2 Open/close button.
- 3 Soft tone multifunction display with infra-red remote control receiver.
- 4 Play button.
- 5 Input port for CD-i pointing devices.
- 6 Stop button.
- 7 AC power on/off button.

DISPLAY

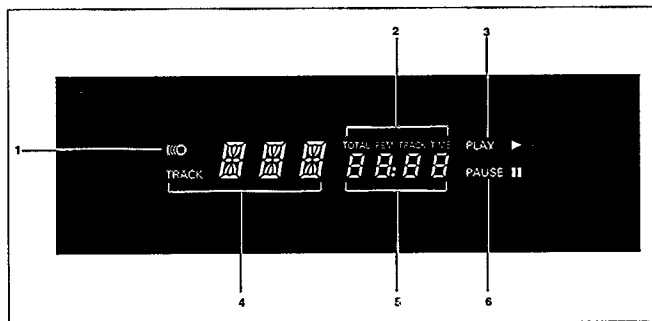

- 1 Remote control active (flashing indicator).
- 2 Time indicators.
- 3 Disc playing.
- 4 Track number (CD-Audio).
- 5 Elapsed or remaining time (CD-Audio).
- 6 CD pause active.

REMOTE CONTROL

- 1 Infra red remote transmitter
- 2 Action button.
- 3 Thumbpad.
- 4 Action buttons (for left or right handed operation).
- 5 Sliding Cover.
- 6 Play button.
- 7 Pause button (CD-Audio + Video CD).
- 8 Stop button (CD-Audio + Video CD).
- 9 Volume control up button.
- 10 Volume control down button.
- 11 CD-i/TV button.
- 12 Next track (CD-Audio + Video CD).
- 13 Previous track (CD-Audio + Video CD).
- 14 Standby*.

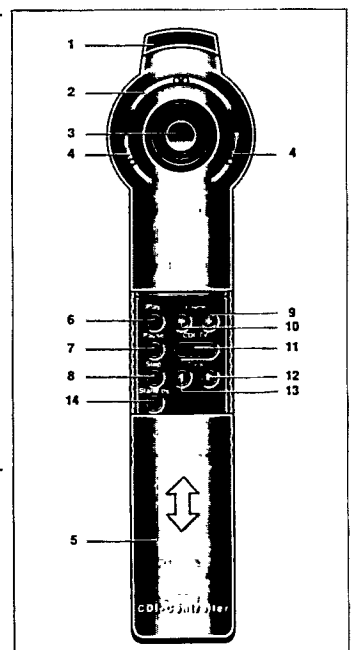

* Available on some player versions only. Not functional for CD-i 210/220.

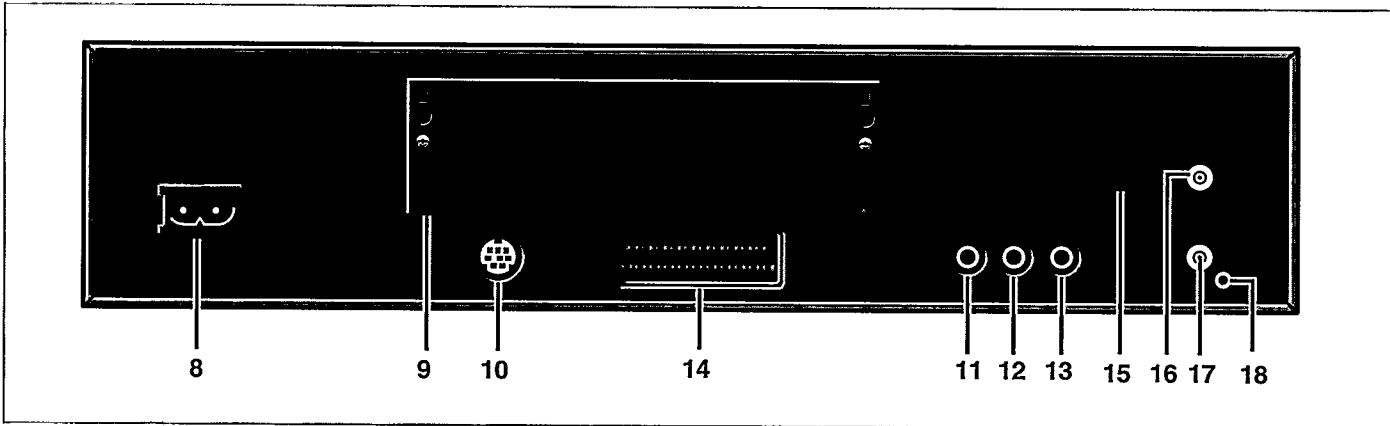

PLACEMENT

- Place the player on a firm, flat surface.
- Keep away from heat sources and direct sunlight.
- In a cabinet, allow 2-3 cm (approx.1 inch) of free space all around the unit for adequate ventilation.

REAR OF PLAYER

- 8 AC Power (alternating current) input socket.
 - 9 Extension socket for 22ER9956 (already installed in some player versions).
 - 10 Input port for CD-i serial connections (Not for pointing devices).
 - 11 Audio output R.
 - 12 Audio output L.
 - 13 Video output (CVBS).
 - 14 A/V Euroconnector*.
 - 15 Channel selector*.
 - 16 Out to TV*.
 - 17 In from antenna*.
 - 18 +5V/Audio out (for optional RF-modulator)*.
- For any optional connection accessories you require, contact your supplier.

*Available on some player versions only.

POWER CONNECTION

- Connect the female end of the AC (alternating current) cord supplied into the AC socket (8).
- Insert the male end of the cord into an AC outlet.

CAUTION

NEVER MAKE OR CHANGE CONNECTIONS WITH THE POWER SWITCHED ON.

ONLY A QUALIFIED SERVICE PERSON SHOULD REMOVE THE COVER OR ATTEMPT TO SERVICE THIS DEVICE.

USE OF CONTROLS OR ADJUSTMENTS OTHER THAN THOSE SPECIFIED HEREIN MAY RESULT IN HAZARDOUS RADIATION EXPOSURE OR OTHER UNSAFE OPERATION.

THE PLAYER AUTOMATICALLY ADJUSTS TO THE LOCAL MAINS VOLTAGE.

WHEN THE PLAYER IS IN THE "OFF" POSITION, IT IS STILL CONSUMING SOME POWER. IF YOU WISH TO DISCONNECT YOUR PLAYER COMPLETELY FROM THE MAINS, THE MAINS-PLUG HAS TO BE DISCONNECTED.

INSTALLATION

English

1. CHOOSING THE RIGHT CONNECTIONS

Most of today's TV receivers have various picture input connections. In order of picture quality, these are:

- A/V Euroconnector (or SCART);
- Video (CVBS);
- Antenna in.

Depending on the version of your player it is advised to connect it to the TV input with the highest picture quality.

NOTE

- Please refer to the instructions that come with the TV set for selection of the correct input.

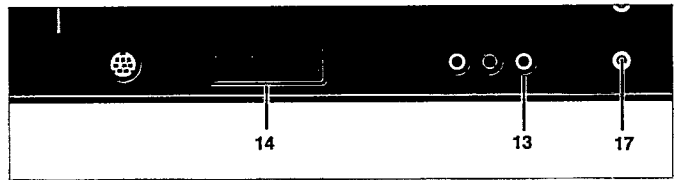

13 Video output (CVBS).

14 A/V Euroconnector*.

17 In from antenna*.

*Available on some player versions only.

2. CONNECTION TO A TV WITH AN A/V EUROCONNECTOR SOCKET

Available on some player versions only.

- Connect the corresponding connectors with the matching cable.

NOTE

- Using the blue Euroconnector of your TV will give the best video quality and depending on the TV set also automatic input switching.
- Please refer to the instructions that come with the TV-set for selection of the correct input.
- Some TV-sets have a pre-set to give the ultimate picture quality when set to CD-i/Photo CD. This setting will only be effective when the blue Euroconnector is used. Please refer to the instructions that come with the TV-set on presets.

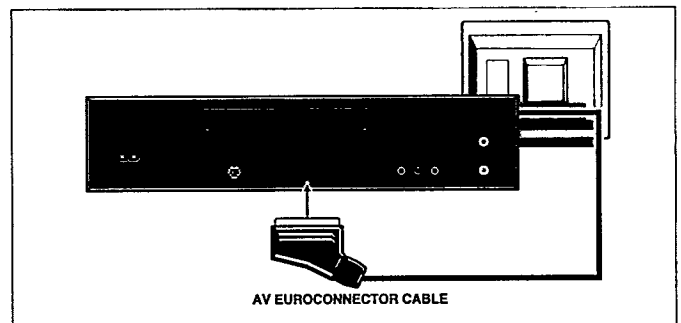

3. CONNECTION TO A TV WITH A VIDEO (CVBS) SOCKET

- Just connect the corresponding connectors with a matching video or CVBS cable.
- This cable does not connect the audio, which has to be connected separately.

NOTE

- Please refer to the instructions that come with the TV set for selection of the correct input.

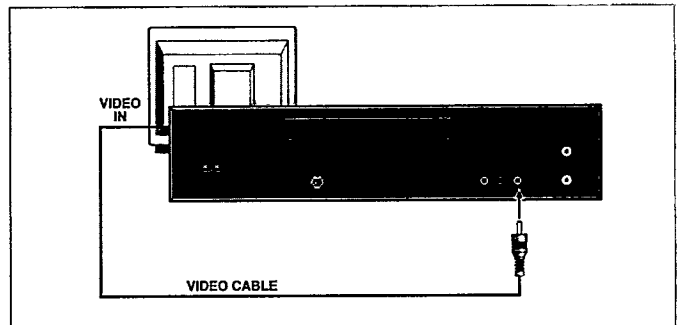

4. ANTENNA CONNECTIONS

Available on some player versions only.

- Connect the player to the TV antenna input, using the matching cable.
- If you already have a VCR (or antenna or cable) connected to the TV antenna input and your CD-i player has an antenna input, connect the CD-i player between the VCR (or antenna or cable) antenna output and the TV antenna input, you may also use an optional external switchbox, if desired.
- Your CD-i player sends pictures and sound to your TV on the channel number indicated on the rear or on the channel selector position (15) at the rear. This signal is sent through the coaxial cable.
- To operate the player with your TV, set your TV to the same channel.
- If your CD-i player has a channel selector (15), located at the rear, you can avoid local interference by tuning to a different channel.

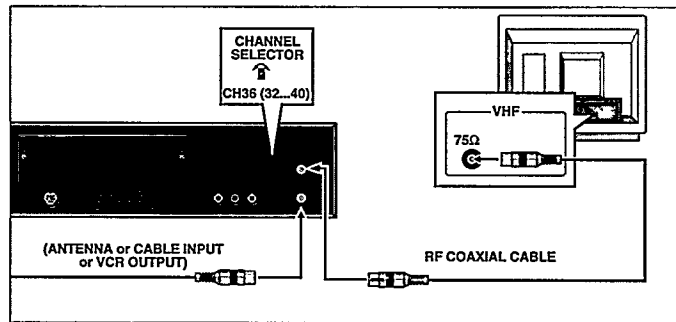

NOTE

- The sound sent through the RF output to your TV is *mono* only.
- Please refer to the instructions that came with the TV-set for the selection of the channel.

5. OTHER VIDEO CONNECTION POSSIBILITIES

If all of the above mentioned inputs of your TV-set are used by other equipment and you are not able to make one of these inputs free the following can be done:

It is possible that your VCR has a video input (CVBS) free (with corresponding audio).

Please connect both audio and video to your VCR. Please refer to the VCR manual how to use this input.

6. AUDIO CONNECTIONS

- If you use the TV antenna input (17) or the A/V Euroconnector (14), the TV will play sound along with the picture.
- If you use the video (CVBS) (13) input, you will also need to connect the player's audio output (11, 12) to the TV's audio input.

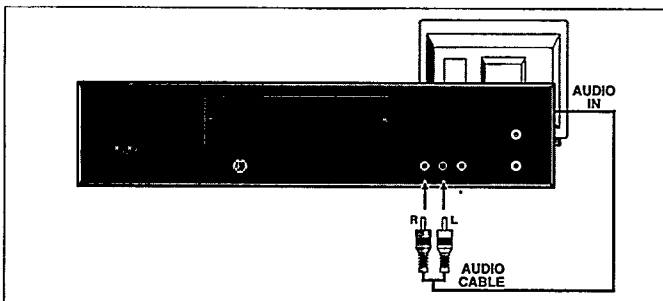

- For HiFi sound, you can connect the player's audio output (11, 12) to the input of your HiFi system, provided that the player, TV and HiFi system are placed close to each other.

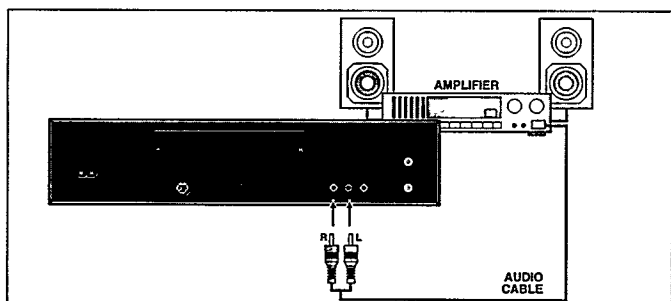

CAUTION

DO NOT CONNECT THE PLAYER'S AUDIO OUTPUT (11, 12) TO THE HI-FI PHONO (RECORD PLAYER)

POINTING DEVICE

English

PRECAUTIONS

To operate your CD-i player a pointing device is needed. For pointing devices other than the included one, please consult your supplier.

CAUTION

NEVER MAKE OR CHANGE CONNECTIONS WITH THE POWER SWITCHED ON.

Pointing devices are sensitive precision instruments. Handle them with care, keeping in mind the following precautions:

- Avoid dropping or knocking
- Do not use them in locations subject to extreme temperatures, humidity, dust or vibration.

INFRA RED REMOTE CONTROL

Loading the batteries in the remote control

- Push and slide the battery compartment cover.
- Insert three 'AA' (R6 or SUM3) batteries as indicated inside the battery compartment.
- Replace the cover.

CAUTION

DO NOT MIX OLD AND NEW BATTERIES. ALSO NEVER MIX DIFFERENT TYPES OF BATTERIES (STANDARD, ALKALINE AND SO ON).

NOTE

- To save battery power, the remote control automatically switches off after approximately one minute if a button is pressed continuously. It is automatically reactivated the next time you press any button.

Remote control interactive operation

For normal interactive operation, use the remote control to select functions displayed on the TV screen.

- Point the remote control at your CD-i player.
- Move the cursor in the direction you want by pressing in that direction on the "Thumbpad".
 - The harder you press the faster the cursor arrow moves.
- Click on one of the action buttons.
 - The function selected by this 'point-and-click' technique is highlighted to confirm the selection.

NOTE

- To 'point-and-click' on any screen shown in this manual, any one of the action buttons can be used.
- The shape of the cursor is different according to the program you are playing, but it is always controlled in the same way.

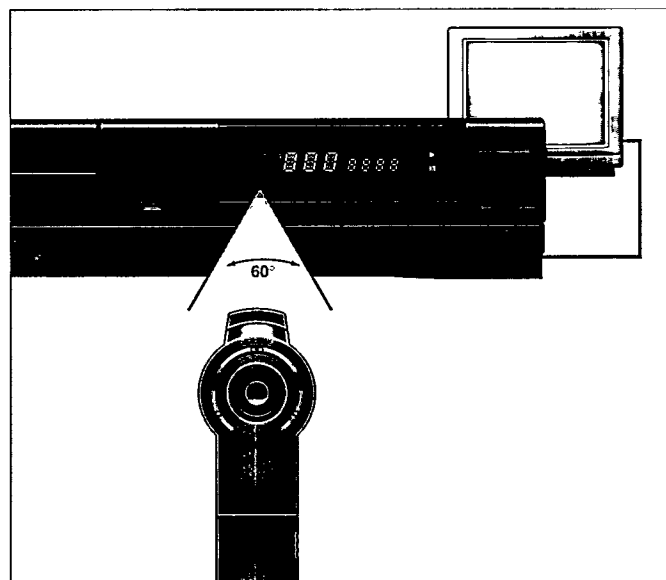
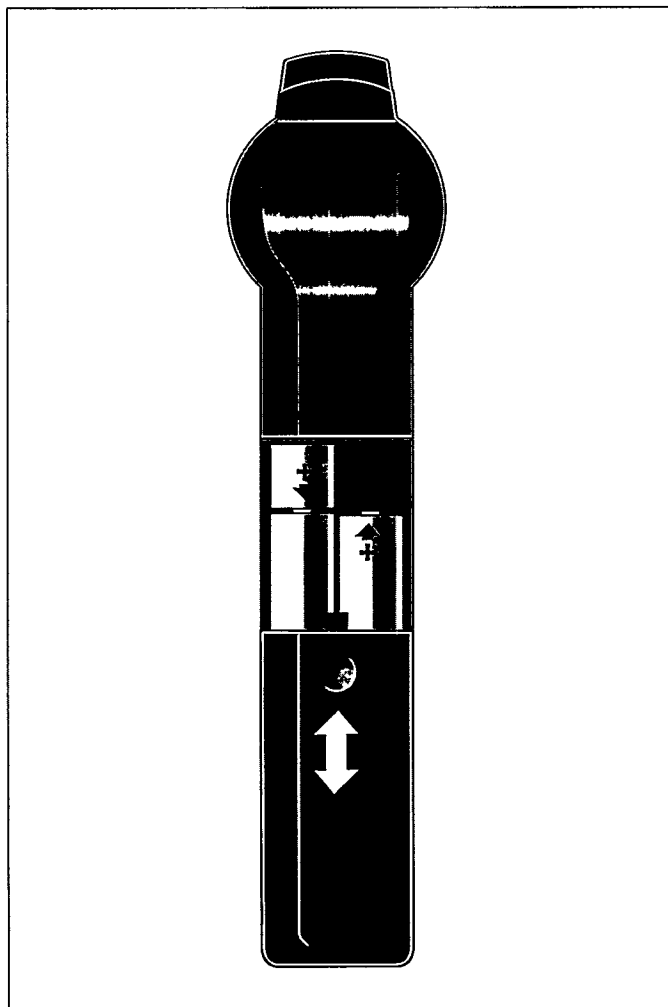

CD-i CONTROLLER

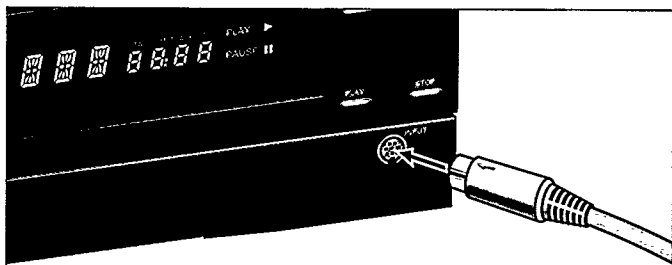

- Another way to operate your CD-i player is by using CD-i controller (optional).
- Press the ON/OFF button (7) to switch the player off.
- Plug the connector of the CD-i controller into the input port (5). Insert the connector with the arrow at the top.
- Switch the player on.
- Move the cursor in the direction you want.
- Click on one of the action buttons.
- The function selected by this "point-and-click" technique is highlighted to confirm the selection.

NOTE

- When simultaneous use of two pointing devices is required by the CD-i title, the optional accessory 22ER9208 (I/O Port Splitter) has to be used to connect these devices to Input (5).
- Optional devices are: Roller Controller, Trackerball, Mouse, Touchpad, Gamepad, Thumbpad (refer to the accessories page on the back of this manual).
- To "point-and-click" on any screen shown in this manual, either one of the two action buttons of the pointing device can be used.
- The shape of the cursor can be different according to the program you are playing, but it is always controlled in the same way.
- Pointing devices are sensitive precision instruments. Handle them with care, keeping in mind the following precautions:
 - Avoid dropping or knocking.
 - Do not use them in locations subject to extreme temperatures, humidity, dust or vibration.
 - Never hold the pointing device by the cable.
 - Never pull the cable to disconnect the pointing device from the player.

CAUTION

NEVER MAKE OR CHANGE CONNECTIONS WITH THE POWER SWITCHED ON.

INSTALLING A DIGITAL VIDEO CARTRIDGE *

As soon as you have plugged this cartridge into your CD-i player, you can play the latest CD-i discs, featuring interactive movies, music videos and state-of-art video games as well as video CD's. Enjoy yourself! But first.....

CAUTION - WHILE INSTALLING (OR REMOVING) YOUR CARTRIDGE, MAKE SURE THE PLAYER IS SWITCHED OFF!

NOTE:

- A special tool is supplied with the cartridge. Keep it safe in case you need it.

INSTALLATION:



Loosen the screws and remove the coverplate.



Push the bracket on the left side down.

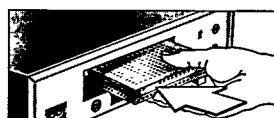

Take hold of the cartridge with connector side pointing to the right. Slide the cartridge in the slot.



Connect the cartridge by pushing it until the bracket goes up.



Then push the cartridge firmly as far as it will go.

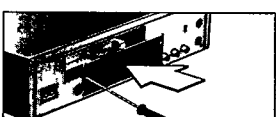

Check if the cartridge is positioned horizontally. Replace the coverplate.

THE CARTRIDGE IS NOW INSTALLED AND SHOULD NOT BE REMOVED WITHOUT CAUSE: IT CARRIES A LOT OF EXTRA MEMORY WHICH IS VALUABLE EVEN FOR TITLES WITHOUT DIGITAL VIDEO (FULL-MOTION).

REMOVAL:



Loosen the screws and remove the coverplate.



Push the bracket on the left side down.

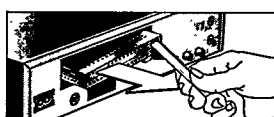

Hook the special extractor tool in the slot of the cartridge and remove the cartridge from the slot.

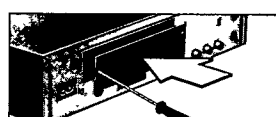

Replace the coverplate.

BEFORE REQUESTING SERVICE!

- SHOULD THE PLAYER MALFUNCTION AFTER CARTRIDGE INSERTION, TRY REMOVING AND REINSERTING IT.
- DO NOT ATTEMPT REPAIRS: THIS WILL INVALIDATE THE WARRANTY.

CAUTION

- DO NOT PROBE INTO THE VENTILATION HOLES!
- DO NOT BLOCK THE VENTILATION HOLES!

** Already installed in some player versions .*

SWITCHING ON AND OFF

- Press the ON/OFF button (7) to switch the player on.
 - Switch on the TV (and HiFi system if used).
 - Select the CD-i input on the TV (and HiFi system if used) to which the CD-i player has been connected..
- On the TV, the player start-up screen will appear. This screen has the following system function icons to guide and assist you:

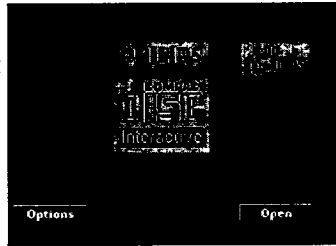

Open/Close:

To open or close the disc tray.

Options:

See: "OPTIONS SCREENS".

To get "Options Screens" click on "Options". To leave "Options Screens" click on "Exit".

- Press the ON/OFF button (7) to switch the player off.
- Switch off the TV (and HiFi system, if used).

OPTIONS SCREENS

1. CD Audio Options

To preselect your preferred settings when playing audio CDs:

Auto shuffle

When the player is switched on, the tracks on the CD will automatically be played in a random order.

Auto FTS

When the player is switched on, the FTS program of the CD will be played automatically

Repeat

Select to repeat a complete audio disc or a single track when the repeat function is activated.

Scan time

Select the time you want the beginning of each audio track to play for (5, 10 or 20 seconds) when the scan function is activated.

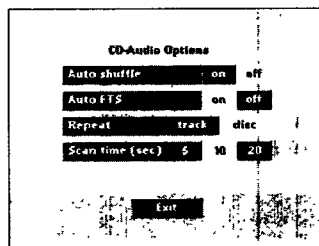

3. Time and Date Options

To change the player time/date settings:

Time/Date set

If the time or date shown on the screen is wrong, select the appropriate ▲ and ▼ arrows to set hours, minutes, day, month and year in turn, as required.

Time format

Select 24 hour or 12 hour clock.

Date format

Select d/m/y to present the date in day-month-year sequence. Select m/d/y to present the date in month-day-year sequence.

Display time/date

Select whether time and date will displayed on the TV screen or not.

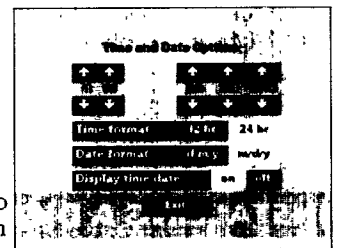

2. General Options

To change the player general settings:

Auto play

When the player is switched on, playback will start automatically when a disc is loaded.

Volume

Selecting the player default volume setting.

16 : 9 screen display

Selecting 16 : 9 screen display, when you have your player connected to a TV with a 16 : 9 screen.

Positioning video

If the player is connected to the TV set via the A/V euroconnector cable (blue euroconnector on TV set; RGB signal) the actual video position on the TV screen is TV set dependent. Activate the positioning button ← or → to optimally center the playershell image on the TV screen.

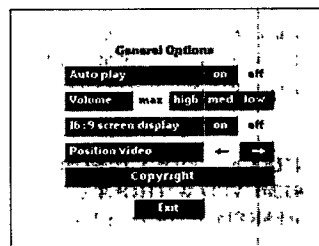

4. Storage Options

To refer to the intermediate results of CD-i titles and the programs created for your audio and Photo CDs.

The 'Storage' screen shows the information held in memory: titles, dates and percentage of memory used.

Clicking on 'Name', 'Date', or 'Size' sorts the information accordingly.

- Use the scroll arrows to move up and down the list.
- To delete an item, click on its title and then click on 'Delete'. If you change your mind after deleting, click on 'Undo'.

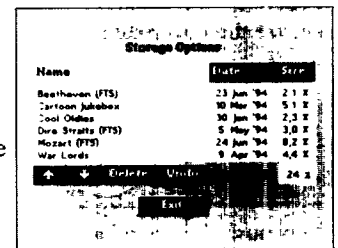

GENERAL

Push button control:

- For basic play control, or for playing discs through a stereo system without using the TV, you can use the buttons on the front panel or on the remote control.
- The PLAY and STOP buttons operate in the same way as the corresponding on-screen functions.
- The NEXT and PREVIOUS buttons skip one track forward or backward respectively.

NOTE

- The functioning of these buttons will depend completely on the application when playing a CD-i program.

Changing over to TV:

- Select the desired channel or input of your TV using the controls of your TV set.
- When the player is switched on, its antenna signal is fed through to the TV and depending on the player-TV connection, TV reception might be interrupted automatically.
- To change over to TV reception at any time in such case, press the CD-i/TV button (11) on the remote control
- To return to CD-i play, press the CD-i/TV button (11) again.

Sound level:

- When playing any disc adjust the sound level as required, preferably on the TV or HiFi amplifier.
- The volume up (9)/down (10) buttons on the remote control may also be used, but for each disc these controls always start at the level set in the General Options Screens. A suitable level must therefore first be set on the TV or HiFi amplifier.

LOADING AND UNLOADING

Loading:

- Point and click on 'Open' (you may also press the OPEN /CLOSE button (2) on the player) to open the disc tray (1).
- Take the disc from its holder and place it on the tray with the label up.
- Point and click on 'Close' (you may also press the OPEN/CLOSE button (2) on the player, or gently push the front of the tray) to close the tray.
- The TV screen changes according to the type of disc.

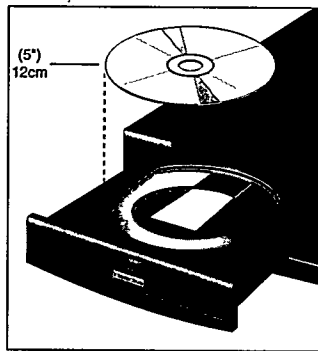

Unloading:

- Point and click on 'Open' (you may also press the OPEN /CLOSE button (2) to open the disc loading tray.
- The player start-up screen reappears on the TV.
- Take the disc from the tray and replace it in its holder.
- Point and click on 'Close' (you may also press the OPEN/CLOSE button (2) on the player, or gently push the front of the tray) to close the tray with or without a new disc.

NOTE

- You may unload the disc at any time by pressing the OPEN/CLOSE button (2).
- Unloading a CD-i disc while the CD-i program is running, will terminate the CD-i program abruptly. 'Bookmarks' or intermediate results, if used by the CD-i program, might not be updated to the latest situation.

CAUTION

NEVER PUT MORE THAN ONE DISC AT A TIME INTO THE CD-i PLAYER

PLAYING A CD-i DISC

Playing a CD-i disc depends on the value of Autoplay (see Options Screens). The factory setting is default "OFF".

1. When autoplay is "OFF":
After the disc is loaded, the CD-i start-up screen appears on the TV. To start the CD-i program, select 'Play' and click on it.
2. When autoplay is "ON":
After the disc is loaded, the CD-i program will start up automatically.

The opening screen of the CD-i program now appears on the TV. From this point, all interaction is between you and the program. To stop at any time, select the STOP or EXIT function provided by the CD-i program.

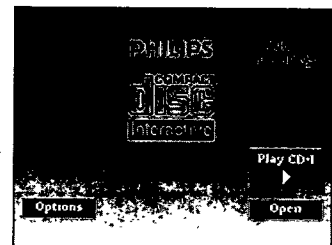

NOTE

- This procedure applies equally to CD BRIDGE discs, CD-i READY discs and PHOTO CDs. And for Digital Video discs and Video CD's when a Digital Video Cartridge has been installed.

CAUTION

NEVER LEAVE A STILL PICTURE ON THE SCREEN FOR ANY LENGTH OF TIME. THIS CAN CAUSE BURNING-IN OF THE PICTURE TUBE. TO AVOID THIS SWITCH OFF THE PLAYER OR REMOVE THE DISC.

PLAYING AN AUDIO CD

I. Using the audio screen

– After the disc is loaded, the CD-Audio screen appears on the TV.

1. PLAY TRACK BAR:

Shows all the track numbers (up to 30). You can 'point-and-click' to select any track. For discs with more than 30 tracks, use the right > and left < scroll arrows to move through the track list.

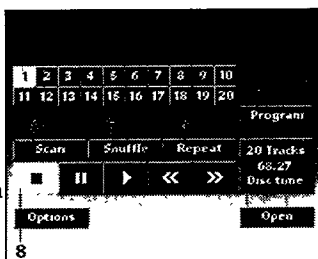

2. **PROGRAM:** Allows you to program a list of special tracks called a Favourite Track Selection. When you select PROGRAM, the FTS track bar and the FTS icon will appear.
3. **FTS:** Allows you to play Favourite Track Selections. This icon only appears if a Favourite Track Selection has been created for the disc that is loaded in the player.
4. **SCAN:** Allows you to listen to the beginning of every track listed in the play track bar. You can set the scan time to 5, 10 or 20 seconds in the 'Options' screen, (see p.10).
5. **SHUFFLE:** Allows you to play the tracks in the play track bar in a random order.
6. **REPEAT:** Allows you to repeat either a track or the entire disc. You can change the repeat mode in the 'Options' screen, (see p.10).
7. **TRACK/TIME** window:
 - In STOP mode, this shows the total number of tracks and the total playing time. When you click at this window (7), the track time of the selected track is displayed.
 - In PLAY and PAUSE modes, the window shows the track number and either the elapsed or the remaining track playing time. To change between elapsed and remaining time, 'point-and-click' at the time shown in the window.
8. All the disc play control functions are shown on the screen, and can be selected as desired by 'point-and-click' with your remote control. The operation of the functions is briefly explained in the following table.

NOTE

– If auto SHUFFLE or auto FTS has been selected on the 'CD Audio' screen, this function will be activated automatically.

OPERATION	SELECT
Start play	PLAY ▶ play starts at the beginning of track 1, or any other preselected track number. If a track is already playing, it is re-started.
Select a track	TRACK number ◀ ▶ if the disc contains more than 30 tracks, use the left < and right > scroll arrows to move through the track numbers as required.
Pause	PAUSE interrupts play.
Exit pause	PAUSE or PLAY ▶ play restarts at exactly the same point as pause was selected.
Forward search	FORWARD ▶▶ searches forward through the disc.
Reverse search	REVERSE ◀◀ searches backwards through the disc.
Stop play	STOP ■ stops playing. If play is re-started, it begins at the first track.
Scan the disc	SCAN plays the beginning of each track listed in the play track bar.
Exit scan	SCAN normal play starts from this point.
Shuffle play	SHUFFLE shuffle sequence appears in track bar.
Exit shuffle	SHUFFLE normal play starts from this point.
Repeat	REPEAT repeats the entire disc (or FTS program), or the track being played, as selected on the "Options" screen.
Play FTS	FTS only available when an FTS program has already been created for the disc in the player.
Exit FTS	EXIT FTS normal play starts from this point.
Program FTS	PROGRAM <ul style="list-style-type: none"> • Point to tracks as required on the play track bar, and in each case click on an action button to enter the track in the FTS track bar. • To cancel an unwanted track, point to it in the FTS track bar and click on an action button. • To cancel the entire FTS program, point to the first track in the FTS track bar and click on an action button repeatedly until all the tracks disappear.
Store FTS	SAVE FTS the keyboard screen replaces the CD-Audio screen. See 'CREATING FTS TITLES' (see p.13).

PLAYING AN AUDIO CD

2. Creating FTS titles

- At the CD-Audio screen (see p.12), 'point-and-click' on the Program button, then 'point-and-click' on the "Save FTS" button.
- The keyboard screen appear.
- Select each character of the title in turn, using Shift to change between upper and lower case characters and Space to separate words.
- Delete erases the last selected character.
- Clear erases the complete (or partially complete) title.
- Cancel returns to the CD-Audio screen without saving the title.
- Save saves the title and returns to the CD-Audio screen.

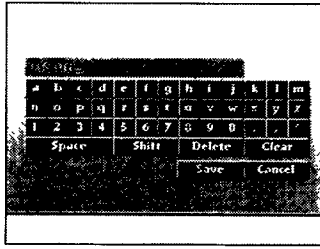

- Using the keyboard screen, you can compose a title of approx. 30 characters (depending on the character width) for the selection.
- After creating an FTS, the title then appears on the CD-Audio screen whenever the disc is loaded.

PLAYING AN AUDIO CD

3. CD graphics

- When an audio CD with graphics is played, the CD Graphics screen will appear automatically.
- To make the picture channel bar appear/disappear click on the action button anywhere outside the channel bar.
- You can select another track number by clicking on 'Track' or either arrow next to it.
- Depending on the disc, other channel numbers might give you other information, such as the lyrics in a different language.
- For information about the actual graphics functions, refer to the instructions that come with the disc.
- To play audio only, click on 'Audio'.

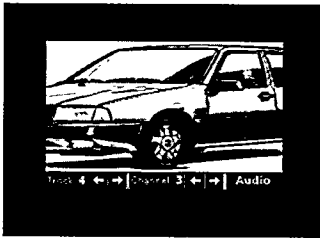

CAUTION

NEVER LEAVE A STILL PICTURE ON THE SCREEN FOR ANY LENGTH OF TIME. THIS CAN CAUSE BURNING-IN OF THE PICTURE TUBE. IN SUCH A CASE SWITCH OFF THE PLAYER OR REMOVE THE DISC.

PLAYING A PHOTO CD

- After loading the disc, the CD-i start-up screen appears on the TV.
- To start the Photo CD program, select the 'PLAY CD-i'; you may also press the PLAY button (5) on the player or remote control (6).
- The opening screen of the Photo CD program now appears on the TV.
- At the bottom of this screen a menu bar with icons is shown.

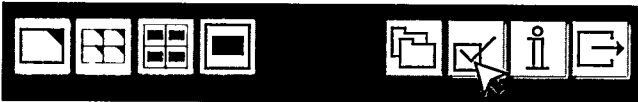

- Select the icon.
- The 'Options' screen will now appear.
- To select a language click on the box, the flag or the name of a country.
- The previous setting will be replaced automatically.

- Select the icon (Return) of this screen to go back to the Photo CD opening screen.



- Select the icon (Information) and the INFORMATION screen, explaining the control buttons of the menu bar in the selected language, appears.
- From this point, all interaction is between you and the program.

CAUTION

NEVER LEAVE A STILL PICTURE ON THE SCREEN FOR ANY LENGTH OF TIME. THIS CAN CAUSE BURNING-IN OF THE PICTURE TUBE. IN SUCH A CASE SWITCH OFF THE PLAYER OR REMOVE THE DISC.

If it appears that the CD-i player is faulty, first consult this check-list.

It may be that something simple has been overlooked.

Under no circumstances attempt to repair the system yourself; this will invalidate the warranty.

- No power** • Check that the ON/OFF button (7) is set to on.
• Check that both plugs on the power cord are properly connected.
• Check that there is power at the AC outlet by plugging in another appliance.
- No picture**..... • Check that the TV is switched on.
• Select the same channel or input on the TV as that of the player.
• Check the video connection.
- Distorted picture**..... • Check the disc for fingerprints and clean with a soft cloth, wiping from centre to edge.
- No open icon on TV screen**..... • Switch the player off, then switch on again while holding the STOP button (6) pressed.
- No start-up. Screen does not change** • Check the disc label is upwards.
• Clean the disc.
• Check if the disc is defective by trying another disc.
- No sound**..... • Check audio connections.
• If using a HiFi amplifier, try another sound source.
- Distorted sound from HiFi amplifier** • Check that audio connections are not made to amplifier Phono input.
- No return to start-up screen when disc is removed**..... • Reset by switching the player off, then on again.
• Check if the CD-i program requires another disc to be loaded.
- The player can't be remote controlled**..... • Aim the remote control directly at the sensor on the player.
• Avoid all obstacles which may interfere with the signal path.
• Inspect or replace the batteries.

SPECIFICATIONS

System • Système • Sistema • System • System • Sistema • Sistema
 CD-Interactive
 CD-Interactif

Usable discs • Disques utilisables • Discos utilizables • Discos Utilizable • Te gobruklen discs • Verwendbare discs • Dischi usabili

CD-i	CD-i
CD-DA	CD-Audio
PHOTO-CD	Photo-CD
CD-i READY	CD-i READY
CD BRIDGE	CD BRIDGE
CD+GRAPHICS	CD+GRAPHICS

Power requirement • Alimentation • Alimentación • Alimentación
Voedingsspanning • Netzanschluß • Alimentazione
 Europe: 100V-240V 50/60Hz
 UK: 100V-240V 50/60Hz

Power consumption • Consommation • Consumo de corriente Opgenomen vermogen • Leistungsaufnahme • Consumo di corrente • Consumo de Corriente
 Europe: 22 W with, 17 W without DVC (22ER9956)
 Europe: 22 W avec, 17 W sans DVC (22ER9956)
 UK: 23 W with, 18 W without DVC (22ER9956)
 UK: 23 W avec; 18 W sans DVC (22ER9956)

Operating temperature • Temperature de fonctionnement
Temperatura de operacion • Bedrijfstemperatuur
Betrijbstemperatuur • Temperatura di funzionamento • Temperatura de funcionamiento
 41°F(5°C) to 95°F(35°C)
 5°C à 35°C

Relative humidity • Humidité relative • Humedad relative
Relatieve vochtigheid • Relative Feuchtigkeit • Umidità relativa • Humedad relativa
 5% to 95% (no condensation)
 5% à 95% (sans condensation)

Weight • Poids • Peso • Gewicht • Gewicht • Peso • Peso
 With DVC: 3,750 kg
 Avec DVC: 3,750 kg
 Without DVC: 3,500 kg
 Sans DVC: 3,500 kg

Dimensions (w x h x d) • Dimensions (l x h x p)
Dimensiones (a x a x p) • Afmetingen (b x h x d)
Abmessungen (B x H x T) • Dimensioni (l x h x p) • Dimensiones (anch. x alt. x prof.)
 420 mm x 90 mm x 286 mm
 16.55" x 3.55" x 11.25"

Input • Entrée • Entrada • Ingang • Eingang • Ingresso • Entradas

REAR
 input (1 ports) 8-pin mini-DIN
 (1 entrées) mini DIN 8 broches



pin Broche	signal Signal	I/O E/S
1	nc	-
2	rxd	I / E
3	txd	O / S
4	nc	-
5	ground / Masse	-
6	cts	I / E
7	rts	O / S
8	+5V (100 mA max)	

Input • Entrée • Entrada • Ingang • Eingang • Ingresso • Entradas

FRONT
 input (1 ports) 8-pin mini-DIN
 (1 entrées) mini DIN 8 broches

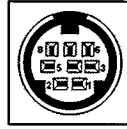

pin Broche	signal Signal	I/O E/S
1	rxd1	I / E
2	rxd2	I / E
3	tx2	O / S
4	rts1	O / S
5	ground / Masse	-
6	nc	-
7	rts2	O / S
8	+5V (100 mA max)	

Output • Sortie • Salida • Uitgang • Ausgang • Uscita • Saídas • Salidas

Audio 2 Vrms
 2 channel individual RCA pin cinch sockets
 2 Veff
 2 prises cinch (une par canal)

video (PAL) 1 Vpp (75 Ohm load, sync neg) RCA pin jack
 1 Vc-c (charge 75 Ohm, sync. nég.) Prise cinch

AV/Euroconnector
 Pérîtélévision AV

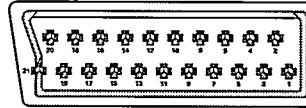

pin Broche	signal Signal
1	audio R / audio R (droite)
2	nc / non connecté
3	audio L / audio L (gauche)
4	audio ground / masse audio
5	blue ground / masse bleu
6	nc / non connecté
7	blue / bleu
8	function switching (0=Antenna ; 1A=AV Euroconnector with aspect ratio 16:9; 1B=AV/Euroconnector with aspect ratio 4:3)
9	green ground / masse vert
10	nc / non connecté
11	green / vert
12	nc / non connecté
13	red ground / masse rouge
14	nc / non connecté
15	red / rouge
16	fast switching (RGB/CVBS) commutation rapide (RVB/CVBS)
17	CVBS ground / masse CVBS (PAL)
18	fast switching (ground) commutation rapide (masse)
19	CVBS/RGB sync / CVBS/RVB sync.
20	nc / non connecté
21	shield / blindage

Note: Pointing device speed of 1200 baud is supported.
 Remarque: Vitesse de transmission jusqu'à 1200 baud. • Nota: Se admite un dispositivo de puntero de 1200 baudios de velocidad. • Opmerking: Voor de aanwijsapparaten is een snelheid van 1200 baud mogelijk. • Hinweis: Die Geschwindigkeit der Zeigevorrichtung von 1200 Baud wird unterstützt. • Nota: Tollera la velocità dell'accessorio di comando di 1200 baud. • Nota: Velocidad del dispositivo de apunta admitida: 1200 baudios.

Designs and specifications are subject to change without notice. • La conception et les spécifications de ce produit sont sujet à modifications sans avis préalable. • Los diseños y las especificaciones están sujetos a cambios sin previo aviso. • Concepten en specificaties kunnen gewijzigd worden zonder voorafgaande verwittiging. • Änderungen von Ausführung und technischen Daten vorbehalten. • I disegni e le specifiche tecniche sono soggette a modifiche senza preavviso. • As especificações descritas estão sujeitas a alteração sem aviso prévio. • El diseño y las especificaciones están sujetos a cambios sin previo aviso.

SUPPLIED ACCESSORIES • ACCESSOIRES FOURNIS

These accessories are provided to help you use or set-up your CD-i Player.

Ces accessoires sont fournis pour vous permettre d'utiliser ou d'installer votre lecteur de CD-i.

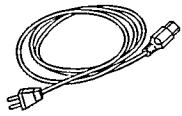

AC Cord
Cordon
d'alimentation

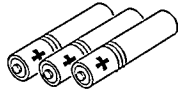

Three Batteries
Trois piles R6



Euroconnector *
Cable
Cable
péritélévision

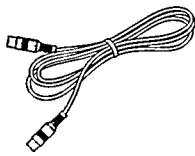

Antenna Cable *
(RF coaxial cable)
Cable d'antenne
(Cable RF)



"Thumbpad"
Remote Control
Handset
Télécommande à
manette

OPTIONAL ACCESSORIES • ACCESSOIRES EN OPTION

Maximize your pleasure with state-of-the-art accessories designed specifically for your CD-i Player.

The optional accessories shown here may be purchased from your supplier.

Augmentez votre plaisir grâce aux accessoires d'avant-garde spécialement conçus pour votre lecteur CD-i.

Les accessoires en option présentés ici peuvent être acquis auprès de votre revendeur.

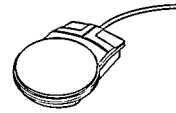

CD-i Mouse
Souris CD-i
22ER9011



Roller Controller
Boule de
commande
22ER9012

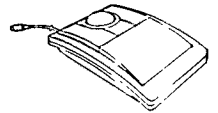

CD-i Trackball
Trackball pour CD-i
22ER9013



Touchpad
Manette de jeux
22ER9017



Gamepad
Clavier de jeux
22ER9021

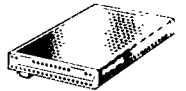

Digital Video
Cartridge
Digital Vidéo
Cartridge
22ER9956

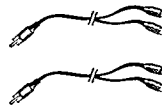

Audio Stereo
Splitter
Doubleur pour
Audio Stereo
22ER9209



I/O Port Splitter for
2 devices
Doubleur pour
dispositif de
pointage pour 2
commandes
22ER9208

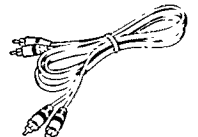

Audio L-R Cable
Double cable
audio stereo
SBA2135A01

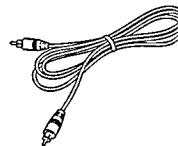

Video (CVBS)
Cable
Cable vidéo
(CVBS)
SBV1127A01

* available on some player versions only * disponible uniquement sur certains modèles de lecteurs * disponible únicamente en determinadas versiones de reproductor * slechts op enkele versies aanwezig * nicht für alle Player-Modelle lieferbar * disponibile solo su alcune versioni di lettore * apenas disponível nalgunas versões

type no. of product • Numéro de série du produit
CDI 210

Date of purchase • Date d'achat • Kaufdatum • Koopdatum • Fecha de compra • Data da compra • Data di acquisto • Købsdato • Kjøpedato • Inköpsdato • Ostopäivä • Ημερομηνία αγοράς

day • Jour month • Mois year • Année 19

Dealer's name, address and signature • Nom, adresse et signature du revendeur • Name, Anschrift und Unterschrift des Händlers • Naam, adres en handtekening van de handelaar • Nombre, dirección y firma del distribuidor • Nome, indirizzo e firma del fornitore • Nome, morada e assinatura do vendedor • Forhandlerens navn, adresse og underskrift • Återförsäljarens namn, adress och namnteckning • Myyjän nimi, osoite ja allekirjoitus • Όνομα/Επώνυμο Αντιπροσώπου

The products and services described herein are not necessarily available in all countries.

Due to continuous product improvements this document is subject to change without notice