

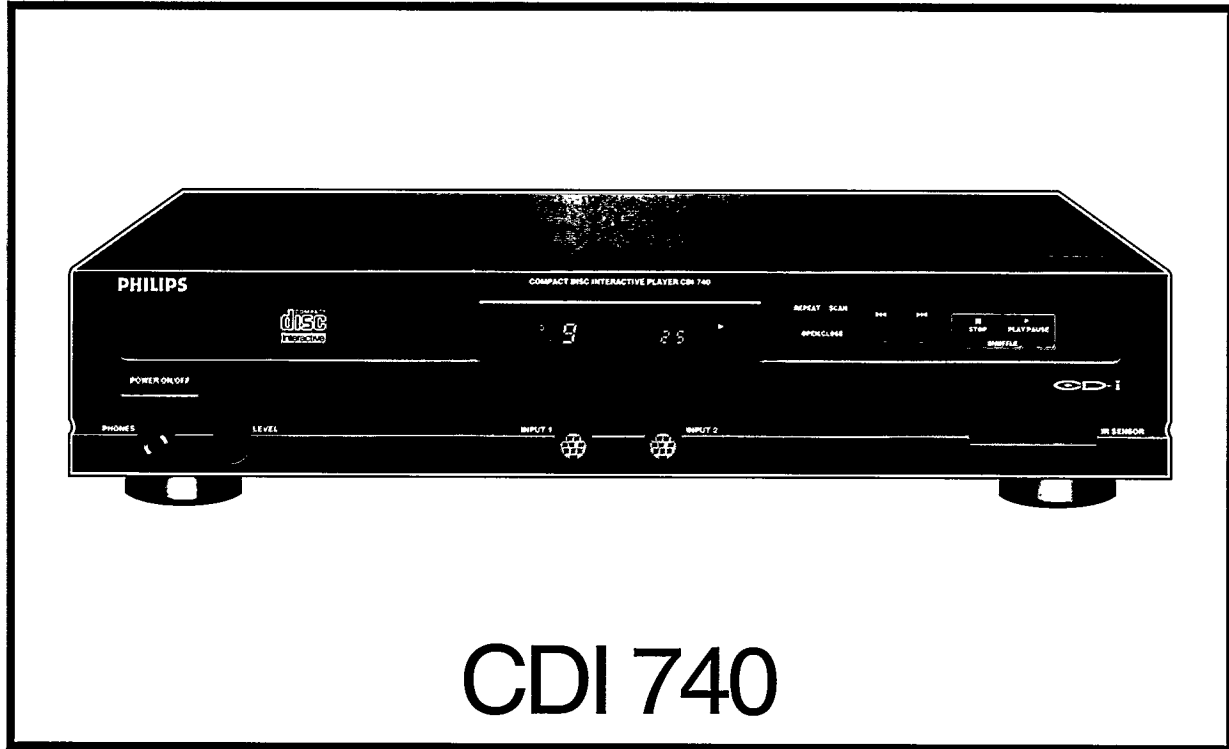

PHILIPS



CDI 740

- GB** User manual
- F** Mode d'emploi
- E** Manual del propietario
- NL** Gebruiksaanwijzing
- D** Bedienungsanleitung
- I** Manuale d'uso
- P** Manual de Utilização

IMPORTANT NOTE FOR USERS IN THE UK

This apparatus is fitted with an approved 13 Amp plug.
To change a fuse in this type of plug, proceed as follows:

1. Remove fuse cover and fuse.
2. Fix new fuse which should be a BS1362 5A, A.S.T.A. or BSI approved type.
3. Refit the fuse cover.

If the fitted plug is not suitable for your socket outlets, it should be cut off and an appropriate plug fitted in its place.

If the mains plug contains a fuse, this should have a value of 5A. If a plug without a fuse is used, the fuse at the distribution board should not be greater than 5A.

NOTE

The severed plug must be destroyed to avoid a possible shock hazard should it be inserted into a 13A socket.

How to connect a plug

The wires in the mains lead are coloured in accordance with the following code:

Blue - 'Neutral' ('N'); Brown - 'Live' ('L')

1. The Blue wire must be connected to the terminal which is marked with the letter 'N' or coloured Black.
2. The Brown wire must be connected to the terminal which is marked with the letter 'L' or coloured Red.
3. Do not connect either wires to the earth terminal in the plug which is marked by the letter 'E' or by the safety earth symbol or coloured green or green-and-yellow.

Before replacing the plug cover, make certain that the cord grip is clamped over the sheath of the lead - not simply over the two wires.

(GB) English.....page 4

Before requesting servicepage 15

English

(F) Françaispage 16

Avant de faire appel au service
apres-ventepage 27

Français

(E) Españolpágina 28

Antes de solicitar servicio técnico.....página 39

Español

(NL) Nederlands.....pagina 40

Problemen en storingenpagina 51

Nederlands

(D) Deutsch.....Seite 52

Bevor Sie den Kundendienst
rufen.....Seite 63

Deutsch

(I) Italiano.....pagina 64

Prima di rivolgersi al centro
assistenzapagina 75

Italiano

(P) Portuguêspag. 76

Antes de chamar a assistência técnica ..pag. 87

Português

For Customer Use:

Read carefully the information located at the bottom of your CD-i player and enter below the Serial N°.

Retain this information for future reference.

Model N°. CDI 740

Serial N°.

LASER SAFETY: This unit employs a laser. Only a qualified service person should remove the cover or attempt to service this device, due to possible eye injury.

NEVER MAKE OR CHANGE CONNECTIONS WITH THE POWER SWITCHED ON.



The CDI 740 is in conformity with the EMC directive and low-voltage directive.

**CLASS 1
LASER PRODUCT**

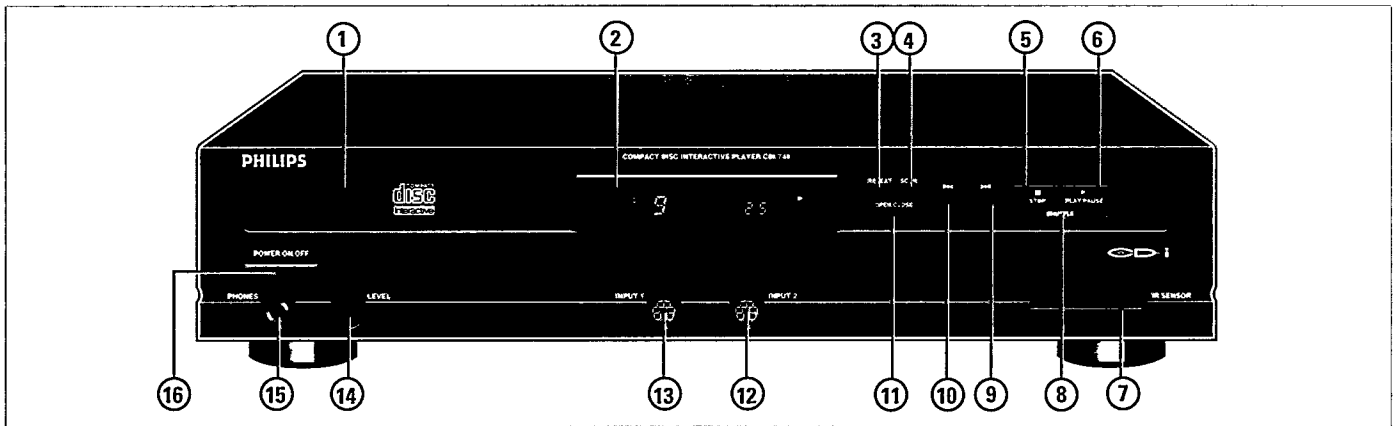

INTRODUCTION

We are pleased to introduce you to one of the most innovative products available today: the Compact Disc Interactive player. You'll be surprised how easy it is! Once correctly hooked up to your TV, you simply 'point-and-click' to explore the intriguing new world of interactive Compact Disc.

Your CD-i player plays beside CD-i and CD-DA (audio compact discs) also the following disc types: Photo CD, CD-i Ready, CD Bridge, CD Extra and CD Graphics (CD+G).

With the installed Digital Video Circuit it also runs interactive Digital Video titles including movies, music videos and high-power action games as well as Video CD's.

A wide variety of optional accessories enhances the player's flexibility. Contact your supplier.

We are confident that you will find this product surprisingly easy to use, and quite unique in its fascination.

The disc types which run on this CD-i player feature one or more of these logos on the disc packaging:



PLACEMENT

- Place the player on a firm, flat surface.
- Keep away from heat sources and direct sunlight.
- In a cabinet, allow 2-3 cm (approx. 1 inch) of free space all around the unit for adequate ventilation.

FRONT OF PLAYER

- 1 Disc loading tray.
- 2 Display.
- 3 Repeat button*.
- 4 Scan button*.
- 5 Stop button**.
- 6 Play/pause button.
- 7 Infra red remote control receiver.
- 8 Shuffle button.
- 9 Next track/search forward button**.
- 10 Previous track/search reverse button**.
- 11 Open/close button.
- 12 Input 2: Connection for pointing device.
- 13 Input 1: Connection for pointing device.
- 14 Headphone volume control.
- 15 Headphone socket.
- 16 Power ON/OFF button.

* Only functional for CD-Audio discs.

** Only functional for CD-Audio and Video CD discs.

DISPLAY

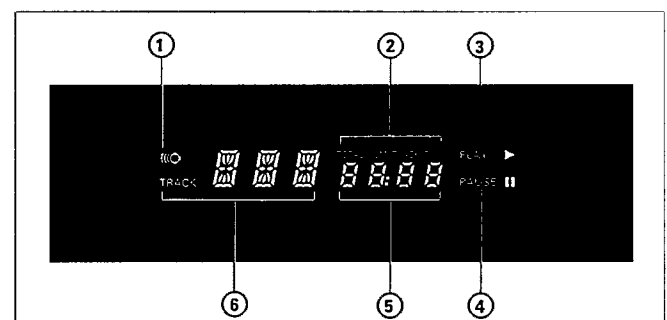

- 1 Remote control active (flashing indicator).
- 2 Time indicators (CD-Audio).
- 3 Disc playing.
- 4 CD pause active (CD-Audio).
- 5 Total, Elapsed or remaining time (CD-Audio).
- 6 Track number (CD-Audio).

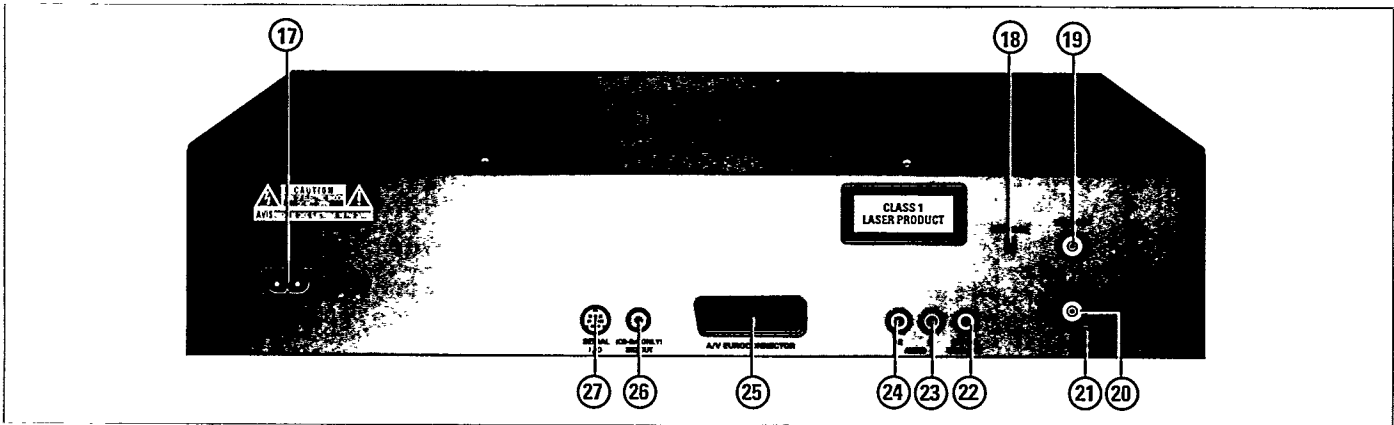

REAR OF PLAYER

- | | |
|--------------------------|---|
| 17 ~ MAINS: | Power connector (AC socket). |
| 18 CH36(30-39): | Channel selector*. |
| 19 Out to TV: | Antenna output to TV*. |
| 20 IN FROM ANT: | In from antenna*. |
| 21 DC OUT +5V/50mA: | +5V/Audio out (for optional RF-modulator)*. |
| 22 (CVBS) VIDEO OUT: | Video output (CVBS). |
| 23 AUDIO L: | Audio output L. |
| 24 AUDIO R: | Audio output R. |
| 25 A/V EUROCONNECTOR: | A/V Euroconnector. |
| 26 DIG OUT (CD-DA ONLY): | Digital output connector. |
| 27 SERIAL I/O: | Serial I/O port. |

*Available on some player versions only.

REMOTE CONTROL

- 1 Stop button**.
- 2 Program button*.
- 3 Repeat button*.
- 4 Action button 1.
- 5 Thumbpad.
- 6 Previous track**.
- 7 Play/Pause button**.
- 8 Infra red remote transmitter.
- 9 Next track**.
- 10 Action button 2.
- 11 Shuffle button*.
- 12 Scan button*.
- 13 CD-i/TV button.
- 14 Disc up button (not functional for CDI 740).
- 15 Volume up button.
- 16 Volume down button.
- 17 Disc down button (not functional for CDI 740).
- 18 Standby (not functional for CDI 740).
- 19 Sliding Cover.

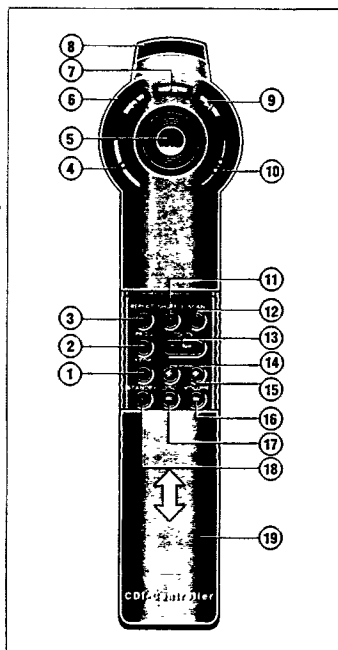

* Only functional for CD-Audio discs.

** Only functional for CD-Audio and Video CD discs.

Depending on the version of CD-i player and availability of connection on the TV set, choose one of the following

connections (1A, 1B or 1C) before connecting the power (2). Connection 1A gives the best picture quality.

1A. CONNECTION TO A TV WITH AN A/V EUROCONNECTOR SOCKET

- Connect the corresponding connectors with the A/V Euroconnector cable.

NOTE

- Please refer to the instructions of your TV set for the correct source selection.

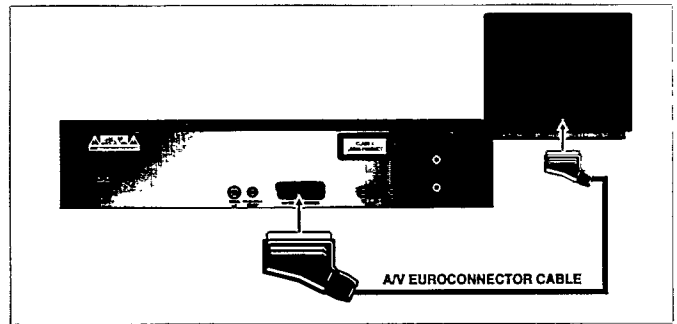

1B. ANTENNA CONNECTIONS

Available on some player versions only.

- Connect the player to the TV antenna input, using the RF Coaxial cable.
- Your CD-i player sends pictures and sound to your TV on the channel number indicated on the rear (18). Therefore select on your TV the same channel.
- You can avoid local interference with other TV stations by tuning the CD-i channel selector (18) to a different channel. In this case adjust your TV to your selected channel.
- When the CD-i player is switched off, the antenna signal (from an external TV antenna, cable connection or VCR antenna signal) will not pass to your TV set. If you want to watch TV when the CD-i is switched off, you have to use an antenna switchbox. Contact your local supplier for this item.

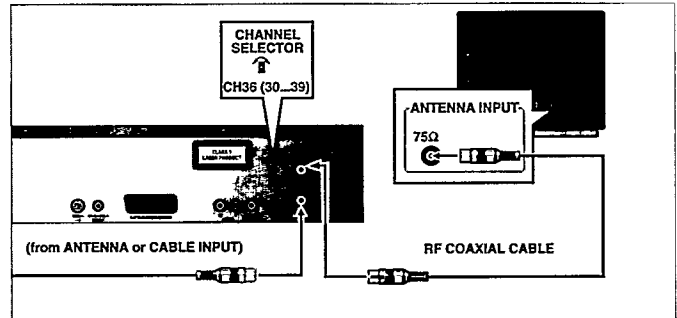

NOTE

- The sound sent through the RF output to your TV set is *mono* only.
- Please refer to the instructions of your TV set for the selection procedures.

1C. CONNECTION TO A TV WITH A VIDEO (CVBS) SOCKET

- Just connect the corresponding sockets with an optional video (CVBS) cable.
- This cable does not connect the audio, which has to be connected separately (with the supplied audio cable).

NOTE

- Please refer to the instructions of your TV set of the correct source selection.

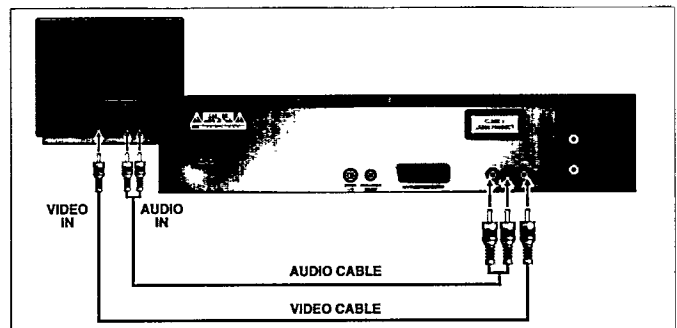

2. POWER CONNECTION

- Connect the corresponding connector of the supplied AC (alternating current) cord to the AC socket (17).
- Insert the other end of the cord into an AC outlet.

CAUTION

NEVER MAKE OR CHANGE CONNECTIONS WITH THE POWER SWITCHED ON.

ONLY A QUALIFIED SERVICE PERSON SHOULD REMOVE THE COVER OR ATTEMPT TO SERVICE THIS DEVICE.

USE OF CONTROLS, ADJUSTMENTS OR PERFORMANCE OF PROCEDURES OTHER THAN THOSE SPECIFIED HEREIN MAY RESULT IN HAZARDOUS RADIATION EXPOSURE OR OTHER UNSAFE CONDITIONS.

THE PLAYER AUTOMATICALLY ADJUSTS TO THE LOCAL MAINS VOLTAGE.

WHEN THE PLAYER IS IN THE "OFF" POSITION, IT IS STILL CONSUMING SOME POWER. IF YOU WISH TO DISCONNECT YOUR PLAYER COMPLETELY FROM THE MAINS, WITHDRAW THE PLUG FROM THE AC OUTLET.

1. AUDIO CONNECTIONS

- If required, you can connect the player's audio output (23,24) to the input of your HiFi system with the supplied audio cable.

CAUTION
DO NOT CONNECT THE PLAYER'S AUDIO OUTPUT (23,24) TO THE PHONO (RECORD PLAYER) INPUT OF YOUR HIFI SYSTEM.

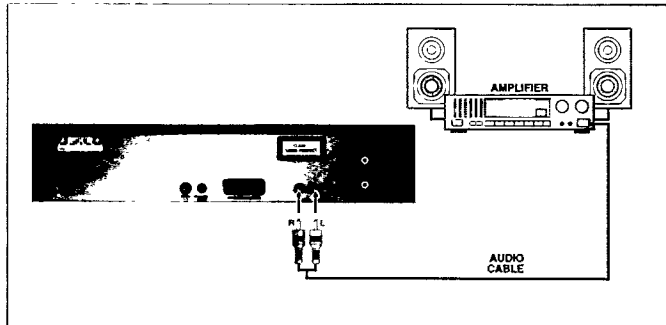

2. DIGITAL OUT CONNECTION

This Digital Output is only active in case of audio discs. This output supplies a digital signal and can therefore only be connected to an input which is suitable for this signal.

CAUTION
NEVER CONNECT THIS SOCKET TO A NON-DIGITAL INPUT OF AN AMPLIFIER, SUCH AS AUX, CD, TAPE, PHONO, ETC.!

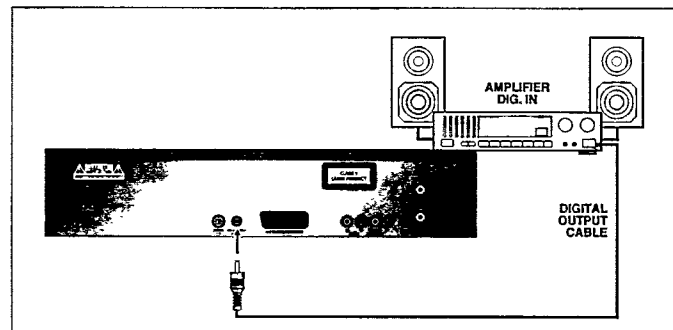

3. OTHER VIDEO CONNECTION POSSIBILITIES

If all of the above mentioned inputs of your TV set are used by other equipment and you are not able to make one of these inputs free, it is possible that your VCR has a video input (CVBS) free (with corresponding audio). In that case connect both audio and video to your VCR. Please refer to the VCR manual how to use this input.

PRECAUTIONS

To operate your CD-i player a pointing device is needed. For pointing devices other than the included one, please consult your supplier.

CAUTION

NEVER MAKE OR CHANGE CONNECTIONS WITH THE POWER SWITCHED ON.

Pointing devices are sensitive precision instruments. Handle them with care, keeping in mind the following precautions:

- Avoid dropping or knocking.
- Do not use them in locations subject to extreme temperatures, humidity, dust or vibration.

INFRA RED REMOTE CONTROL

Loading the batteries in the remote control

- Push and slide the battery compartment cover.
- Insert three 'AA' (R6 or UM3) batteries as indicated inside the battery compartment.
- Replace the cover.

CAUTION

DO NOT MIX OLD AND NEW BATTERIES. ALSO NEVER MIX DIFFERENT TYPES OF BATTERIES (STANDARD, ALKALINE AND SO ON).

NOTE

- To save battery power, the remote control automatically switches off after approximately one minute if a button is pressed continuously. It is automatically reactivated the next time you press any button.

Remote control interactive operation

For normal interactive operation, use the remote control to select functions displayed on the TV screen.

- Point the remote control at your CD-i player.
- Move the cursor in the direction you want by pressing in that direction on the "Thumbpad".
 - The harder you press the faster the cursor arrow moves.
- Click on one of the action buttons.
 - The function selected by this 'point-and-click' technique is highlighted to confirm the selection.

NOTE

- To 'point-and-click' on any screen shown in this manual, any of the action buttons can be used.
- The shape of the cursor is different according to the program you are playing, but it is always controlled in the same way.

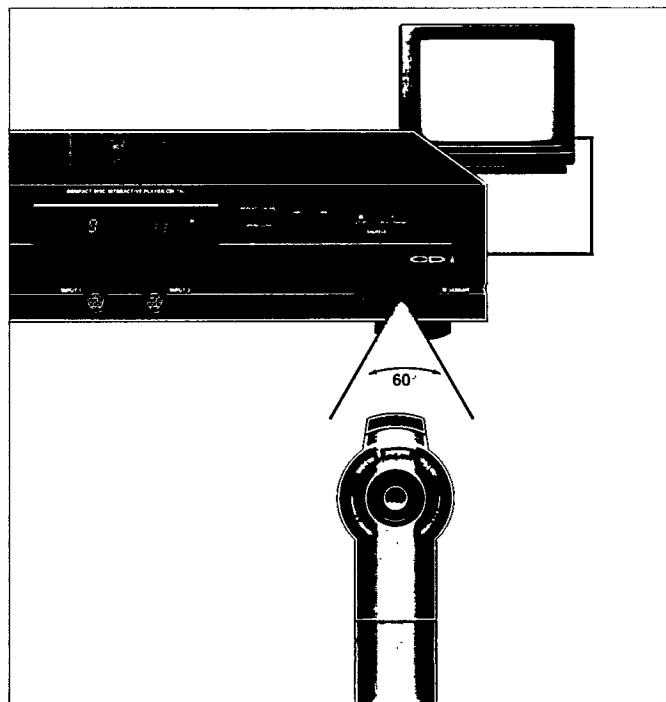
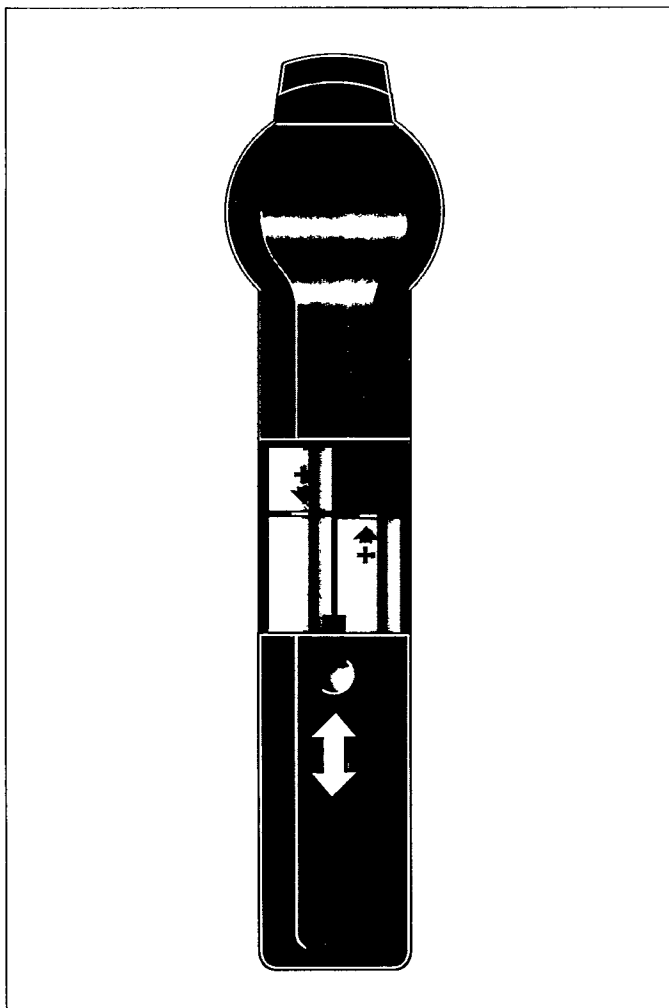

CD-i CONTROLLER

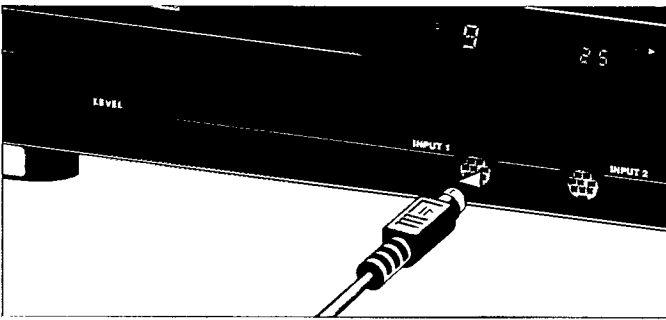

For some applications, other types of pointing devices, keyboards or controllers may be required. These CD-i controllers can be connected to Input 1 (13) and 2 (12) on the front of the player. Optional devices are: Roller Controller, Trackerball, Mouse, Gamepad (refer to the accessories page on the back of this manual). For further information on this subject, please contact your national Philips organization.

- Press the ON/OFF button (16) to switch the player off.
- Plug the connector of the CD-i controller into the input (12,13). Insert the connector with the arrow facing upwards.
- Switch the player on.
- Move the cursor in the direction you want.
- Click on one of the action buttons.
- The function selected by this "point-and-click" technique is highlighted to confirm the selection.

NOTE

- To "point-and-click" on any screen shown in this manual, any of the action buttons of the pointing device can be used.
- The shape of the cursor can be different according to the program you are playing, but it is always controlled in the same way.
- Pointing devices are sensitive precision instruments. Handle them with care, keeping in mind the following precautions:
 - Avoid dropping or knocking.
 - Do not use them in locations subject to extreme temperatures, humidity, dust or vibration.
 - Never hold the pointing device by the cable.
 - Never pull the cable to disconnect the pointing device from the player.
 - When only one pointing device is used, preferably connect it to input 1 to avoid problems with the infra red remote control.

CAUTION

NEVER MAKE OR CHANGE CONNECTIONS WITH THE POWER SWITCHED ON.

SWITCHING ON AND OFF

Switching on:

- Press the ON/OFF button (16) to switch the player on.
- Switch on the TV (and HiFi system if used).
- Select the input on the TV (and HiFi system if used) to which the CD-i player is connected.
- On the TV, the player start-up screen will appear. This screen has the following system function icons to guide and assist you:

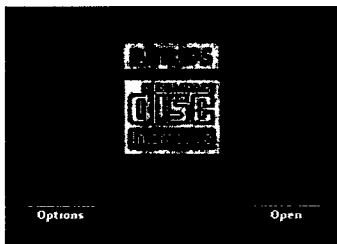

Open/Close:

To open or close the disc tray.

Options:

See: "OPTIONS SCREENS".

To get "Options Screens" click on "Options". To leave "Options Screens" click on "Exit".

Switching off:

- Press the ON/OFF button (16) to switch the player off.
- Switch off the TV (and HiFi system, if used).

OPTIONS SCREENS

1. General Options

To change the player general settings:

Auto play

When the player is switched on, playback will start automatically when a disc is loaded and the tray is closed.

Volume

Selecting the player default volume setting.

16 : 9 screen display

Selecting 16 : 9 screen display, when you have your player connected to a TV with a 16 : 9 screen.

Digital Scan

This option provides adapted video output for TV sets with 'Digital Scan' feature (The name for this feature can differ per TV brand).

'Digital Scan' ON:

- The player is optimised for 'Digital Scan' TV sets to display the best possible picture quality.

'Digital Scan' OFF:

- The player is now set to generate the best picture quality for non-'Digital Scan' TV sets.

NOTE

- When the 'OFF' mode is used in combination with a 'Digital Scan' TV set, it can result in a fuzzy picture, due to the double action of the Digital Scan feature in the CD-i and in the TV set.
- Please, check also the instructions manual of your TV set.

Positioning video

If the player is connected to the TV set via the A/V Euroconnector cable (blue Euroconnector on TV set; RGB signal) the actual video position on the TV screen is TV set dependent. Activate the positioning button ← or → to optimally center the image on the TV screen.

2. CD Audio Options

To preselect your preferred settings when playing audio CDs:

Auto shuffle

When the player is switched on, the tracks on the CD will automatically be played in a random order.

Auto FTS (Favourite Track Selection)

When the player is switched on, the FTS program of the CD will be played automatically.

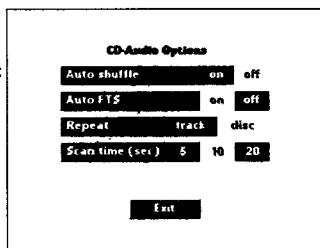
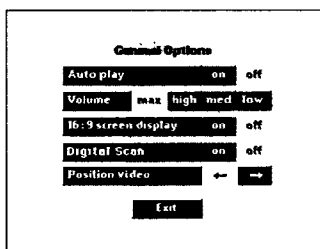

Repeat

Select to repeat a complete audio disc or a single track when the repeat function is activated.

Scan time

Select the time you want the beginning of each audio track to play for (5, 10 or 20 seconds) when the scan function is activated.

3. Time and Date Options

To change the player time/date settings:

Time/Date set

If the time or date shown on the screen is wrong, select the appropriate ▲ and ▼ arrows to set hours, minutes, day, month and year in turn, as required.

Time format

Select 24 hour or 12 hour clock.

Date format

Select d/m/y to present the date in day-month-year sequence. Select m/d/y to present the date in month-day-year sequence.

Display time/date

Select whether time and date will be displayed on the TV screen or not.

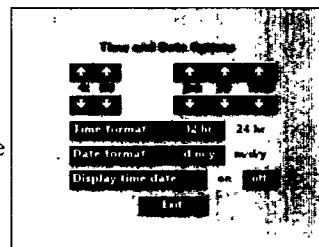

4. Storage Options

results of CD-i titles and the programs created for your audio and Photo CDs.

information held in memory: titles, dates and percentage of memory used.

'Size' sorts the information accordingly.

- Use the scroll arrows to move up and down the list.
- To delete an item, click on its title and then click on 'Delete'. If you change your mind after deleting, click on 'Undo'.

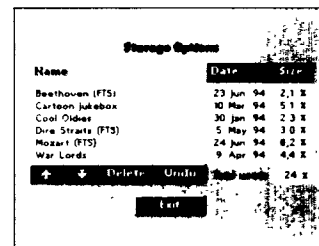

GENERAL

Push button control:

For play control you can use the buttons on one of the following items:

- the front pannel of the CD-i player.
- the remote control.
- the on-screen function displayed on the TV.

The corresponding buttons on these items operate in the same way.

Sound level:

- When playing any disc adjust the sound level as required, preferably on the TV or HiFi amplifier.
- The volume up (15)/down (16) buttons on the remote control may also be used, but for each disc these controls always start at the level set in the General Options Screens. A suitable level must therefore first be set on the TV or HiFi amplifier.

LOADING AND UNLOADING

Loading:

- Point and click on 'Open' (you may also press the OPEN /CLOSE button (11) on the player) to open the disc tray (1).
 - Take the disc from its holder and place it on the tray with the label facing upwards.
 - Point and click on 'Close' (you may also press the OPEN/CLOSE button (11) on the player, or gently push the front of the tray) to close the tray.
- The TV screen changes according to the type of disc.

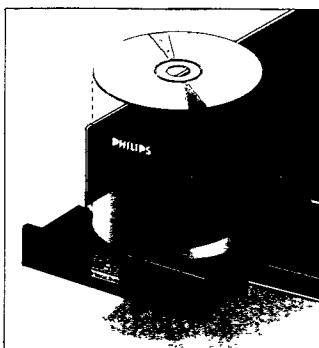
**Unloading:**

- Point and click on 'Open' (you may also press the OPEN /CLOSE button (11) to open the disc loading tray.
- The player start-up screen reappears on the TV.
- Take the disc from the tray and replace it in its holder.
- Point and click on 'Close' (you may also press the OPEN/CLOSE button (11) on the player, or gently press the front of the tray) to close the tray with or without a new disc.

NOTE

- You may unload the disc at any time by pressing the OPEN/CLOSE button (11).
- Unloading a CD-i disc while the CD-i program is running, will terminate the CD-i program abruptly. 'Bookmarks' or intermediate results, if used by the CD-i program, might not be updated to the latest situation.

CAUTION

NEVER PUT MORE THAN ONE DISC AT A TIME INTO THE CD-i PLAYER

PLAYING A CD-i DISC

Playing a CD-i disc depends on the value of Autoplay (see Options Screens). The factory setting is default "OFF".

1. When autoplay is "OFF":
After the disc is loaded, the CD-i start-up screen appears on the TV. To start the CD-i program, select 'Play' and click on it.

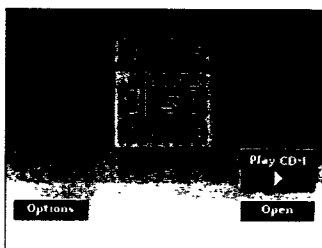

2. When autoplay is "ON":
After the disc is loaded, the CD-i program will start up automatically.
- This procedure applies equally to all disc standards.

The opening screen of the CD-i program now appears on the TV. From this point, all interaction is between you and the program. To stop at any time, select the STOP or EXIT function provided by the CD-i program.

CAUTION

NEVER LEAVE A STILL PICTURE ON THE SCREEN FOR ANY LENGTH OF TIME. THIS CAN CAUSE BURNING IN OF THE PICTURE TUBE. TO AVOID THIS, SWITCH OFF THE PLAYER OR REMOVE THE DISC.

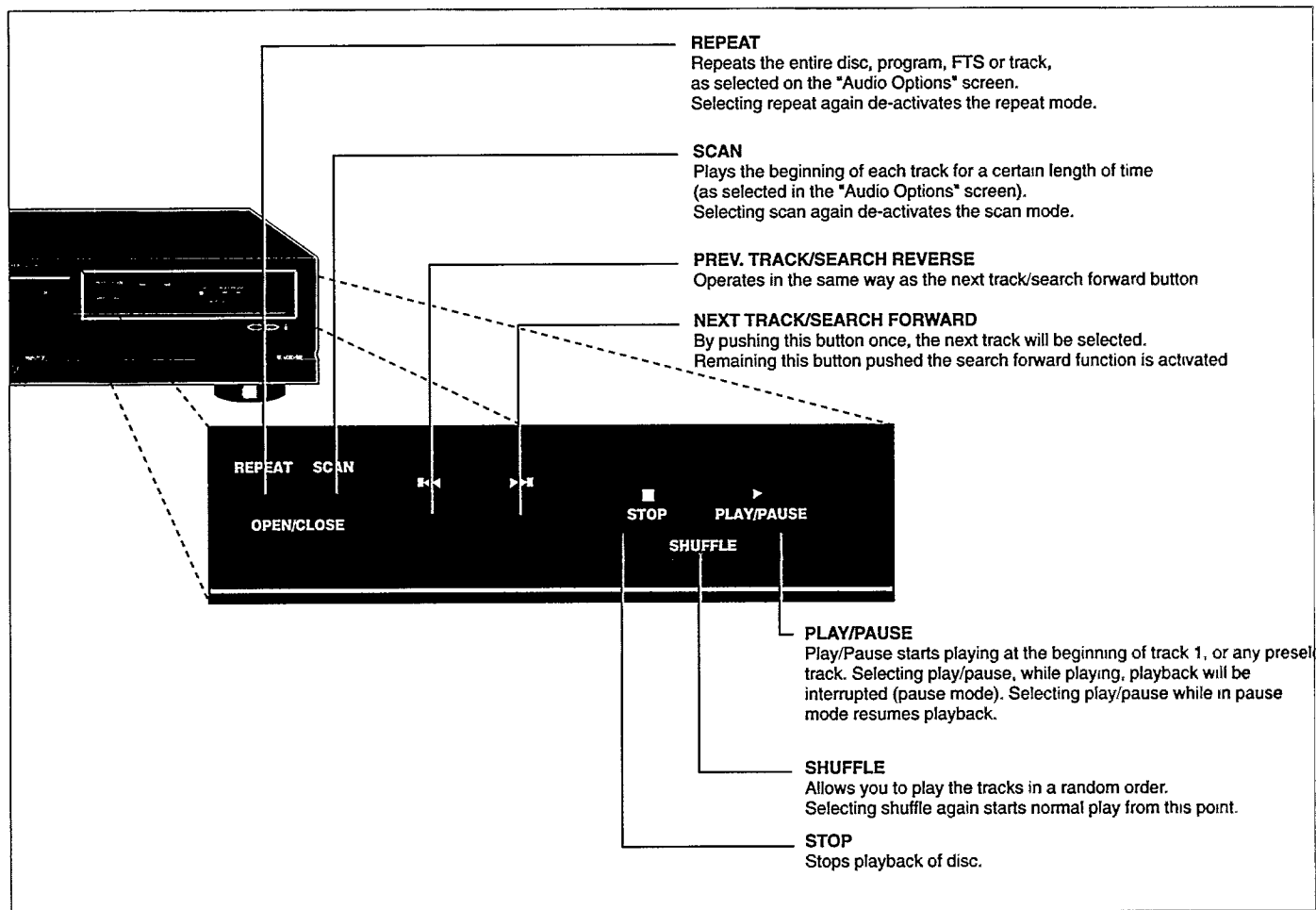

Program button on remote control

Allows you to make a list of tracks in your favourite order.

To make a program list:

Push PROGRAM to select program mode.

1. Select the preferred track by pushing the NEXT/PREV. TRACK button.

2. Select PROGRAM to confirm this track.

3. Continue step 1 and 2 till the selection of tracks is finalised.

4. Select PLAY.

This program list can be deleted after pushing STOP in stop mode, or by pushing STOP twice in play mode.

NOTE

- This program list will not be saved automatically.
- This program list can be saved and/or edited via the CD-Audio screen on the TV.

NOTE

- The PLAY/PAUSE, STOP, NEXT/PREV. TRACK buttons on both, the front panel and infra red remote control, are also functional for Video CD discs.

PLAYING AN AUDIO CD

1B. Using the audio screen

- After the disc is loaded, the CD-Audio screen appears on the TV.

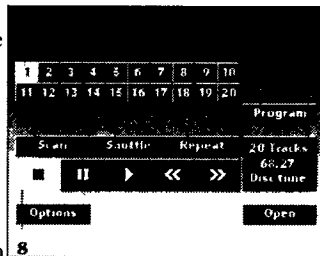
**1. PLAY TRACK BAR:**

Shows all the track numbers (up to 30). You can 'point-and-click' to select any track. For discs with more than 30 tracks, use the right > and left < scroll arrows to move through the track list.

- 2. PROGRAM:** Allows you to program a list of special tracks called a Favourite Track Selection. When you select PROGRAM, the FTS track bar and the FTS icon will appear.
- 3. FTS:** Allows you to play Favourite Track Selections. This icon only appears if a Favourite Track Selection has been created for the disc that is loaded in the player.
- 4. SCAN:** Allows you to listen to the beginning of every track listed in the play track bar. You can set the scan time to 5, 10 or 20 seconds in the 'Options' screen, (see p.10).
- 5. SHUFFLE:** Allows you to play the tracks in the play track bar in a random order.
- 6. REPEAT:** Allows you to repeat either a track or the entire disc. You can change the repeat mode in the 'Options' screen, (see p.10).
- 7. TRACK/TIME window:**
- In STOP mode, this shows the total number of tracks and the total playing time. When you click at this window (7), the track time of the selected track is displayed.
 - In PLAY and PAUSE modes, the window shows the track number and either the elapsed or the remaining track playing time. To change between elapsed and remaining time, 'point-and-click' at the time shown in the window.
- 8.** All the disc play control functions are shown on the screen, and can be selected as desired by 'point-and-click' with your remote control. The operation of the functions is briefly explained in the following table.

NOTE

- If auto Shuffle, auto Play or auto FTS has been selected on the 'CD Audio' screen, this function will be activated automatically.
- If an FTS has been created for the disc you have loaded, then CD-FTS flashes alternately on the local display.

OPERATION	SELECT
Start play	PLAY ► play starts at the beginning of track 1, or any other preselected track number. If a track is already playing, it is re-started.
Select a track	TRACK number if the disc contains more than 30 tracks, use the left < and right > scroll arrows to move through the track numbers as required.
Pause	PAUSE II interrupts play.
Exit pause	PAUSE II or PLAY ► play restarts at exactly the same point as pause was selected.
Forward search	FORWARD ►► searches forward through the disc.
Reverse search	REVERSE ◀◀ searches backwards through the disc.
Stop play	STOP ■ stops playing. If play is re-started, it begins at the first track.
Scan the disc	SCAN plays the beginning of each track listed in the play track bar.
Exit scan	SCAN normal play starts from this point.
Shuffle play	SHUFFLE shuffle sequence appears in track bar.
Exit shuffle	SHUFFLE normal play starts from this point.
Repeat	REPEAT repeats the entire disc (FTS or program), or the track being played, as selected on the "Options" screen.
Play FTS	FTS only available when an FTS program has already been created for the disc in the player.
Exit FTS	FTS normal play starts from this point.
Program FTS	PROGRAM <ul style="list-style-type: none"> • Point to tracks as required on the play track bar, and in each case click on an action button to enter the track in the FTS track bar. • To cancel an unwanted track, point to it in the FTS track bar and click on an action button. • To cancel the entire FTS program, point to the first track in the FTS track bar and click on an action button repeatedly until all the tracks disappear.
Store FTS	SAVE FTS the keyboard screen replaces the CD-Audio screen. See 'CREATING FTS TITLES' (see p.14).

PLAYING DISCS

PLAYING AN AUDIO CD

2. Creating FTS titles

- At the CD-Audio screen (see p.13), 'point-and-click' on the Program button, then 'point-and-click' on the "Save FTS" button.
- The keyboard screen appear.
- Select each character of the title in turn, using Shift to change between upper and lower case characters and Space to separate words.
- Delete erases the last selected character.
- Clear erases the complete (or partially complete) title.
- Cancel returns to the CD-Audio screen without saving the title.
- Save saves the title and returns to the CD-Audio screen.

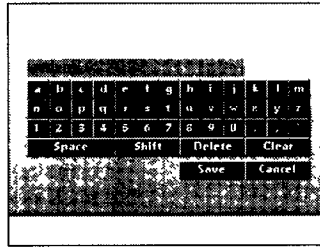

- Using the keyboard screen, you can compose a title of approx. 30 characters (depending on the character width) for the selection.
- After creating an FTS, the title then appears on the CD-Audio screen whenever the disc is loaded.

PLAYING AN AUDIO CD

3. CD graphics

- When an audio CD with graphics is played, the CD Graphics screen will appear automatically.
- To make the picture channel bar appear/disappear click on the action button anywhere outside the channel bar.
- You can select another track number by clicking on 'Track' or either arrow next to it.
- Depending on the disc, other channel numbers might give you other information, such as the lyrics in a different language.
- For information about the actual graphics functions, refer to the instructions that come with the disc.
- To play audio only, click on 'Audio'.

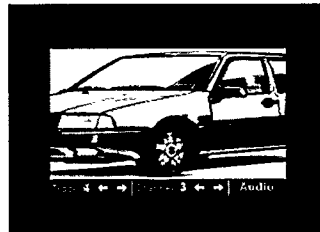

CAUTION

NEVER LEAVE A STILL PICTURE ON THE SCREEN FOR ANY LENGTH OF TIME. THIS CAN CAUSE BURNING IN OF THE PICTURE TUBE. TO AVOID THIS, SWITCH OFF THE PLAYER OR REMOVE THE DISC.

PLAYING A PHOTO CD

- After loading the disc, the CD-i start-up screen appears on the TV.
- To start the Photo CD program, select the 'PLAY CD-i'; you may also press the PLAY/PAUSE button (6) on the player or remote control (7).
- The opening screen of the Photo CD program now appears on the TV.
- At the bottom of this screen a menu bar with icons is shown.



- Select the  icon.
- The 'Options' screen will now appear.
- To select a language click on the box, the flag or the name of a country.
- The previous setting will be replaced automatically.

- Select the  icon (Return) of this screen to go back to the Photo CD opening screen.

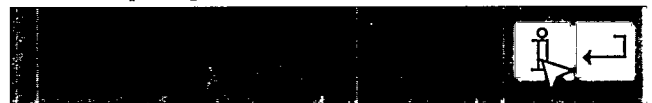

- Select the  icon (Information) and the INFORMATION screen, explaining the control buttons of the menu bar in the selected language, appears.
- From this point, all interaction is between you and the program.

CAUTION

NEVER LEAVE A STILL PICTURE ON THE SCREEN FOR ANY LENGTH OF TIME. THIS CAN CAUSE BURNING IN OF THE PICTURE TUBE. TO AVOID THIS, SWITCH OFF THE PLAYER OR REMOVE THE DISC.

If it appears that the CD-i player is faulty, first consult this checklist.

It may be that something simple has been overlooked. Under no circumstances attempt to repair the system yourself; this will invalidate the warranty.

Look for the specific symptom(s) which you encounter with your CD-i player. Then follow only the actions which are stated as remedy for this specific symptom(s).

SYMPTOM

REMEDY

- No power**
- Check if the ON/OFF button (16) on the front of the player is set to on.
 - Check if both plugs of the mains cord are properly connected.
 - Check if there is power at the AC outlet by plugging in another appliance.

- No picture**.....
- Check if the TV is switched on.
 - Select the same channel and source on the TV as on the player.
 - Check the video connection.

- Distorted picture**.....
- Check the disc for fingerprints and clean with a soft cloth, wiping from centre to edge.

- The tray cannot be opened**
- In this case "TRAY LOCKED" can be displayed in the lower center of the CD-i screen on the television. The open icon, (normally in the lower right of the screen) is not displayed.
 - Switch the player OFF, then switch ON again while simultaneously holding the STOP button (5) pressed, for at least 5 seconds.

- Disc can't be played**.....
- Ensure the disc label is upwards.
 - Clean the disc.
 - Check if the disc is defective by trying another disc.

- No sound**.....
- Check audio connections.
 - If using a HiFi amplifier, try another sound source.

- Distorted sound from HiFi amplifier**
- Check to make sure that no audio connections are made to amplifier phono input.

- No return to start-up screen when disc is removed**.....
- Reset by switching the player OFF, then ON again.
 - Check to see if the CD-i program requires another disc to be loaded.

- The player can't be controlled (While using an infra red remote control)**.....
- Aim the remote control directly at the sensor on the front of the player (7).
 - Avoid all obstacles which may interfere with the signal path.
 - Inspect or replace the batteries.
 - Check that no pointing device is connected to input 2.

SYMPTOM

REMEDY

- The player can't be controlled (While using a wired CD-i controller)**.....
- Check the CD-i controller connection.
 - Switch the player OFF, then switch ON again.

Cleaning Discs

Some problems occur because the disc inside the CD-i player is dirty. Some CD-i applications will give a "dirty disc" message themselves. To avoid these problems clean your discs regularly, in the following way:

- When a disc becomes dirty, clean it with a cleaning cloth. Wipe the disc from the centre out.
- Do not use solvents such as benzine, thinner, commercially available cleaners, or anti-static spray intended for analog discs.

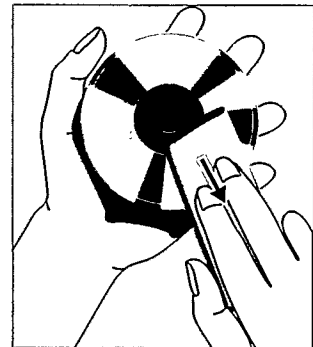

NOTES

SPECIFICATIONS

System • Système • Sistema • System • Sistema • Sistema
 CD-Interactive
 CD-Interactif

Usable discs • Disques utilisables • Discos utilizables • Discos Utilizable • Te
 gebruiken discs • Verwendbare discs • Dischi usabili

CD-i	CD EXTRA
CD-DA	CD GRAPHICS
PHOTO-CD	VIDEO CD
CD-i READY	
CD BRIDGE	

Power requirement • Alimentation • Alimentación • Alimentación
 Voedingsspanning • Netzanschluss • Alimentazione

Europe: 100V-240V AC	50/60Hz
UK: 100V-240V AC	50/60Hz

Power consumption • Consommation • Consume de corriente • Opgenomen
 vermogen • Leistungsaufnahme • Consumo di corrente • Consomo de Corriente
 PLAY 20W approx
 POWER OFF 1,3W approx

Operating temperature • Temperature de fonctionnement

Temperatura de operacion • Bedrijfstemperatuur
 Betriebstemperatur • Temperatura di funzionamento • Temperatura de fun-
 cionamiento
 41°F to 95°F
 5°C to 35°C

Relative humidity • Humidité relative • Humedad relative
 Relatieve vochtigheid • Relative Feuchtigkeit • Umidità relativa • Humedad
 relativa

5% to 95% (no condensation)
 5% à 95% (sans condensation)

Weight • Poids • Peso • Gewicht • Gewicht • Peso • Peso
 3,55 kg approx

Dimensions (w x h x d) • Dimensions (l x h x p)
 Dimensiones (a x a x p) • Afmetingen (b x h x d)
 Abmessungen (B x H x T) • Dimensioni (l x h x p) • Dimensiones (anch. x alt.
 x prof.)

435 mm x 105 mm x 285 mm
 17 1/8" x 4.13" x 11.25"

CONNECTIONS • BRANCHEMENTS • CONEXIONES • AANSLUITINGEN •
 ANSCHLÜSSE • COLLEGAMENTI • LIGAÇÕES

DC OUT connector (rear)* • Connecteur DC OUT (arrière)* • Salida de c.c.
 (DC OUT) (panel posterior)* • DC OUT (achterzijde)* • DC-OUT-Anschluss
 (Rückseite)* • Connettore DC OUT (sul retro)* • Conector DC OUT (atrás)*

for optional external RF mod.
 socket for 2.5 mm stereo jack
 tip +5V / 50mA
 ring Audio mono out
 shield GND

* available on some player versions only * disponible uniquement sur certains
 modèles de lecteurs * disponible únicamente en determinadas versiones de re-
 productora * slechts op enkele versies aanwezig * nicht für alle Player-Modelle lief-
 erbar * disponibile solo su alcune versioni di lettore * apenas disponível nalgunas
 versões

Digital out (rear) • Sortie numérique (arrière) • Salida digital (panel posterior)
 • Digitale uitgang (achterzijde) • Digitaler Ausgang (Rückseite) • Uscita digit-
 ale (sul retro) • Saída digital (atrás)

0,5 Vpp into 75 ohm
 RCA pin cinch socket

serial I/O (rear) • E/S série (arrière) • Entrada/salida en serie (panel posterior)
 • Serielle I/O (achterzijde) • Serieller E/A (Rückseite) • I/O seriale (sul retro) •
 E/S em série (atrás)

(1 ports) 8-pin mini-DIN
 (1 entrées) mini-DIN 8 broches

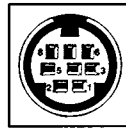

pin Broche	signal Signal	I/O E/S
1	nc	-
2	rx	I/E
3	tx	O/S
4	nc	-
5	ground / Masse	-
6	cts	I/E
7	rts	O/S
8	+5V (100 mA max)	

Serial communication at 9600 baud • Communication série à 9600 bauds •
 Comunicación en serie a 9.600 baudios • Serielle communicatie-aansluiting
 (9600 baud) • Serielle Kommunikation mit 9600 Baud • Comunicazione seriale a
 9600 baud • Comunicação em série a 9600 baud

Pointing device input 1 and input 2 (front) • Entrée 1 et entrée 2 pour dis-
 positif de pointage (avant) • Entradas 1 y 2 del dispositivo de mando (panel
 frontal) • Ingang 1 en 2 voor aanwijsapparaten (voorzijde) • Zeilgegerät-
 Eingang 1 und Eingang 2 (Frontseite) • Ingresso 1 e Ingresso 2 del puntatore
 (sul pannello anteriore) • Entrada 1 e 2 do dispositivo apontador (à frente)

(2 ports) 8-pin mini-DIN for CD-i pointing devices
 (2 entrées) mini-DIN 8 broches

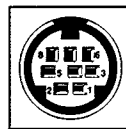

mini-DIN input 1 • Entrée 1 mini-DIN • Entrada 1, conector
 miniDIN • mini-DIN-ingang 1 • Mini-DIN-Eingang 1 •
 Ingresso 1 mini-DIN • Entrada 1 mini-DIN

pin Broche	signal Signal	I/O E/S
1	n.c.	-
2	rx	I
3	tx	-
4	n.c.	-
5	gnd	-
6	n.c.	-
7	rts	O
8	+5V (100 mA max)	O
levels	TTL	

mini-DIN input 2 • Entrée 2 mini-DIN • Entrada 2, conector
 miniDIN • mini-DIN-ingang 2 • Mini-DIN-Eingang 2 •
 Ingresso 2 mini-DIN • Entrada 2 mini-DIN

pin Broche	signal Signal	I/O E/S
1	n.c.	-
2	rx	I
3	n.c.	O
4	n.c.	-
5	gnd	-
6	n.c.	-
7	rts	O
8	+5V (100 mA max)	O
levels	TTL	

Note: Pointing device speed of 1200 baud is supported.
 Remarque: Vitesse de transmission jusqu' à 1200 baud. • Nota: Se admite un dis-
 positivo de puntero de 1200 baudios de velocidad. • Opmerking: Voor de
 aanwijsapparaten is een snelheid van 1200 baud mogelijk. • Hinweis: Die
 Geschwindigkeit der Zeilgevorrichtung von 1200 Baud wird unterstützt. • Nota:
 Tollera la velocità dell'accessorio di comando di 1200 baud. • Nota: Velocidad
 del dispositivo de apunta admitida: 1200 baudios.

SPECIFICATIONS

Audio out • Sortie audio • Salida de audio • Audio-uitgang • Audio-Ausgang • Uscita audio • Saída de áudio

2 V_{rms}
2 channel individual RCA pin cinch sockets
2 V_{eff}
2 prises cinch (une par canal)

Video out (PAL) • Sortie vidéo • Salida de vídeo • Video-uitgang • Video-Ausgang • Uscita video • Saída de vídeo

1 V_{pp} (75 Ohm load, sync neg) RCA cinch socket
1 V_{c-c} (charge 75 Ohm, sync. nég.) Prise cinch

A/V Euroconnector • A/V Péri-télévision • A/V Euroconector • A/V Euroconnector • A/V Euro-Anschluß • A/V Euroconnector • Euroconector A/V

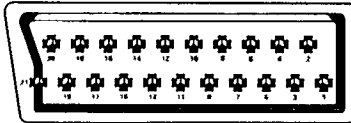

pin Broche	signal Signal
1	audio R / audio R (droite) 1,8 V _{rms}
2	nc / non connecté
3	audio L / audio L (gauche) 1,8 V _{rms}
4	audio ground / masse audio
5	blue ground / masse bleu
6	nc / non connecté
7	blue / bleu (0,7V _{pp} into 75ohm*)
8	function switching 0V=asp.ratio 4:3 from antenna +4V=asp.ratio 16:9 from AV conn. +10V=asp.ratio 4:3 from AV conn. commutation fonction (0=Antenna 1A=Péri-télévision A/V avec ratio 16:9; 1B=Péri-télévision A/V avec ratio 4:3)
9	green ground / masse vert
10	nc / non connecté
11	green / vert (0,7V _{pp} into 75ohm*)
12	nc / non connecté
13	red ground / masse rouge
14	nc / non connecté
15	red / rouge (0,7V _{pp} into 75ohm*)
16	fast switching (RGB/CVBS) (2,5dc into 75ohm) commutation rapide (RVB/CVBS)
17	CVBS ground / masse CVBS (PAL)
18	fast switching (ground) commutation rapide (masse)
19	CVBS/RGB sync / CVBS (1V _{pp} into 75ohm*) / RVB sync.
20	nc / non connecté
21	shield / blindage

* for 100% white

Headphone • Casque • Auriculares • Hoofdtelefoon • Kopfhörer • Cuffie • Auscultador

Socket for 6.3 mm stereo jack
8-2000 ohm
30mw @ 32 ohm

RF-Modulator* • Modulateur H.F.* • Modulador RF (radiofrecuencia)* • HF-modulator* • HF-Modulator* • Modulateur RF* • Modulador-RF*

- Channel selector CCIR: CH 30-39
CCIR: CH 30-39
Preset: CH 36
Preset: CH 36

- Out to TV 75 Ohm (IEC-M connector)
75 Ohm (IEC-M connecteur)
73 dB μ V (CD-i to TV)
73 dB μ V (CD-i TV)

Note: CD-i-off = no antenna loopthrough

- In from antenna 75 Ohm (IEC-F connector)
75 Ohm (IEC-F connecteur)

- Booster gain = 2dB (ant. in to out to TV)
= 2dB (Entrée pour antenne à sortie TV)

* available on some player versions only * disponible uniquement sur certains modèles de lecteurs * disponible únicamente en determinadas versiones de reproductor * slechts op enkele versies aanwezig * nicht für alle Player-Modelle lieferbar * disponibile solo su alcune versioni di lettore * apenas disponível nalgunas versões

Designs and specifications are subject to change without notice. • La conception et les spécifications de ce produit sont sujet à modifications sans avis préalable. • Los diseños y las especificaciones están sujetos a cambios sin previo aviso. • Concepten en specificaties kunnen gewijzigd worden zonder voorafgaande vermittigen • Änderungen von Ausführung und technischen Daten vorbehalten • I disegni e le specifiche tecniche sono soggette a modifiche senza preavviso. • As especificações descritas estão sujeitas a alteração sem aviso prévio. • El diseño y las especificaciones están sujetos a cambios sin previo aviso.

ACCESSORIES • ACCESSOIRES

SUPPLIED ACCESSORIES • ACCESSOIRES FOURNIS

These accessories are provided to help you use or set-up your CD-i Player.

Ces accessoires sont fournis pour vous permettre d'utiliser ou d'installer votre lecteur de CD-i.

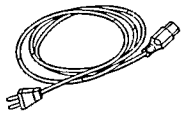

AC Cord
Cordon d'alimentation

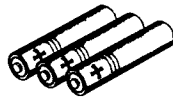

Three Batteries
Trois piles R6



A/V Euroconnector^{*}
Cable
Cable péritélévision

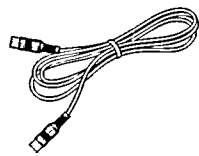

Antenna Cable^{*}
(RF coaxial cable)
Cable d'antenne
(Cable RF)



"Thumbpad"
Remote Control
Handset
Télécommande à manette

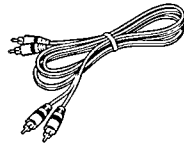

Audio L-R Cable
Double cable
audio stereo
SBA2135A01

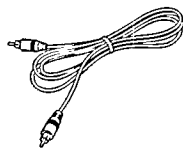

Digital out Cable
Cable dig. out

OPTIONAL ACCESSORIES • ACCESSOIRES EN OPTION

Maximize your pleasure with state-of-the-art accessories designed specifically for your CD-i Player.

The optional accessories shown here may be purchased from your supplier.

Augmentez votre plaisir grâce aux accessoires d'avant-garde spécialement conçus pour votre lecteur CD-i.

Les accessoires en option présentés ici peuvent être acquis auprès de votre revendeur.



Gamepad
Clavier de jeux
22ER9021



Roller Controller
Boule de commande
22ER9012



CD-i Trackball
Trackball pour CD-i
22ER9013



CD-i Mouse
Souris CD-i
22ER9011

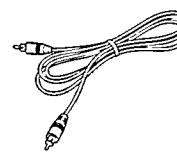

Video (CVBS)
Cable
Cable vidéo
(CVBS)
SBV1127A01



Audio Stereo
Splitter
Doubleur pour
Audio Stereo
22ER9209

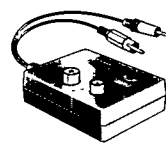

RF Modulator
Modulateur RF
22ER9071

^{*} available on some player versions only • disponible uniquement sur certains modèles de lecteurs • disponible únicamente en determinadas versiones de reproductor • slechts op enkele versies aanwezig • nicht für alle Player-Modelle lieferbar • disponibile solo su alcune versioni di lettore • apenas disponível nas algumas versões

type no. of product • Numéro de série du produit
CDI 740

Date of purchase • Date d'achat • Kaufdatum • Koopdatum • Fecha de compra • Data da compra • Data di acquisto • Købsdato • Kjøpedato • Inköpsdato • Ostopäivä • Ημερομηνία αγοράς

day • Jour month • Mois year • Année 19

The products and services described herein are not necessarily available in all countries.

Due to continuous product improvements this document is subject to change without notice



Dealer's name, address and signature • Nom, adresse et signature du revendeur • Name, Anschrift und Unterschrift des Händlers • Naam, adres en handtekening van de handelaar • Nombre, dirección y firma del distribuidor • Nome, indirizzo e firma del fornitore • Nome, morada e assinatura do vendedor • Forhandlerens navn, adresse og underskrift • Återforsäljarens namn, adress och namnteckning • Myyjän nimi, osoite ja allekirjoitus • Όνομα/Επώνυμο Αντιπροσώπου